



## ADVANCED MANUAL

---

FM TRANSCEIVER  
**IC-V3500**

---

---

---

---

---

---

---

---

---

---

### INTRODUCTION

1 ADVANCED OPERATIONS

2 REPEATER OPERATION

3 MEMORY OPERATION

4 SCAN OPERATION

5 PRIORITY WATCH

6 DTMF MEMORY

7 TONE SQUELCH AND POCKET BEEP

8 SET MODES

9 OTHER FUNCTIONS

10 PROGRAMMING

11 INSTALL AND CONNECTIONS

12 TROUBLESHOOTING

---

Thank you for choosing this Icom product. This product is designed and built with Icom's state of the art technology and craftsmanship. With proper care, this product should provide you with years of trouble-free operation.

---

## ABOUT THE MANUALS

(As of April 2022)

You can use the following manuals to understand and operate this transceiver.

- **Basic Manual (Comes with the transceiver)**  
Instructions for basic operations.
- **Marine Channel Mode Guide (Comes with the transceiver)**  
Instructions for the Marine Channel mode and the related functions in English.  
① This guide may not be included, depending on the transceiver version.
- **Advanced Manual (This manual)**  
Instructions for advanced operations in English.

### For Reference

- **HAM Radio Terms (PDF type)**  
A glossary of HAM radio terms in English.

---

## TRADEMARKS

Icom and the Icom logo are registered trademarks of Icom Incorporated (Japan) in Japan, the United States, the United Kingdom, Germany, France, Spain, Russia, Australia, New Zealand, and/or other countries. Adobe, Acrobat, and Reader are either registered trademarks or trademarks of Adobe Systems Incorporated in the United States and/or other countries. All other products or brands are registered trademarks or trademarks of their respective holders.

# FUNCTIONS AND FEATURES OF ADOBE® ACROBAT® READER®

The following functions and features can be used with Adobe® Acrobat® Reader®.

- **Keyword search**

Click “Find (Ctrl+F)” or “Advanced Search (Shift+Ctrl+F)” in the Edit menu to open the search screen.

This is convenient when searching for a particular word or phrase in this manual.

① The menu screen may differ, depending on the Adobe Acrobat Reader version.

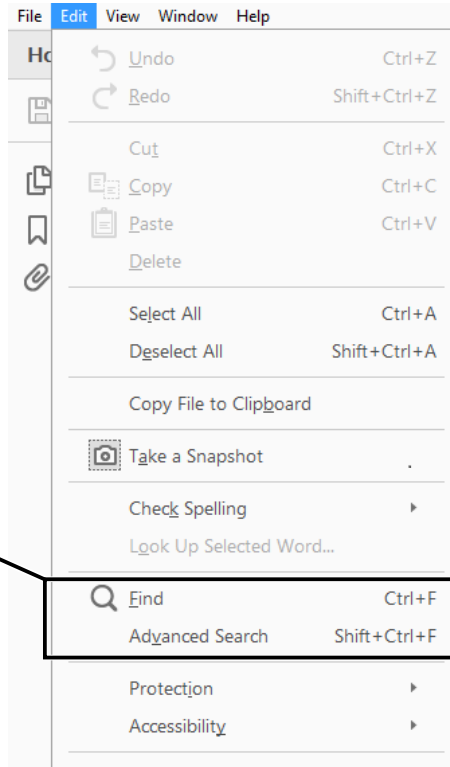

- **Find screen**

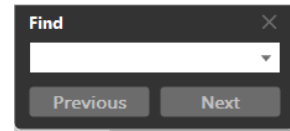

- **Advanced search screen**

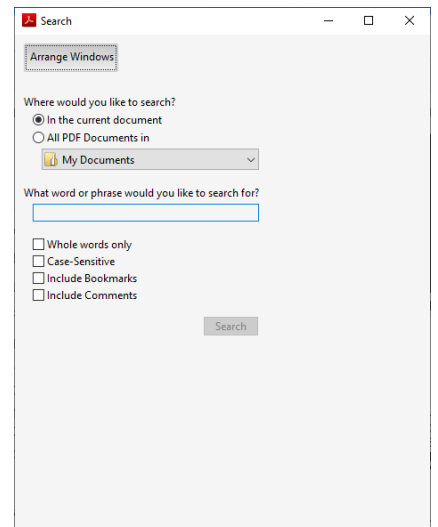

Click to open the find or search screen or advanced search screen.

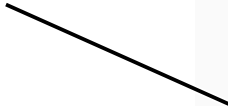

- **Printing out the desired pages.**

Click “Print” in the File menu, and then select the paper size and page numbers you want to print.

① The printing setup may differ, depending on the printer. Refer to your printer’s instruction manual for details.

② Select “A4” size to print out the page in the original manual size.

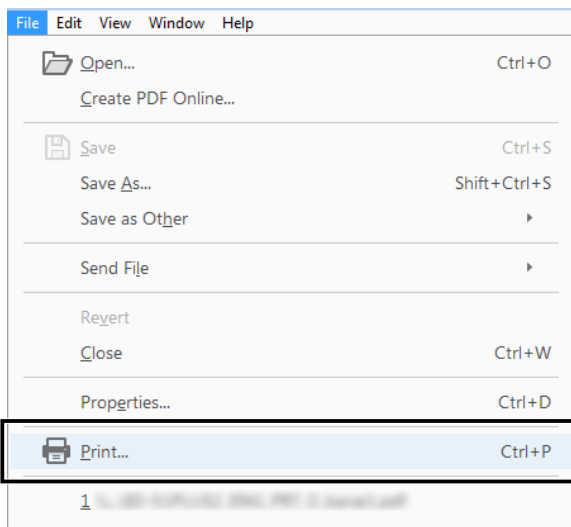

- **Read Out Loud feature.**

The Read Out Loud feature reads aloud the text in this PDF.

Refer to the Adobe Acrobat Reader Help for the details.

(This feature may not be usable, depending on your PC environment including the operating system.)

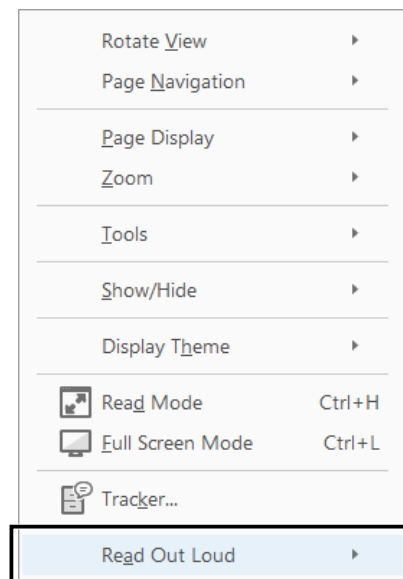

① The screen may differ, depending on the Adobe Acrobat Reader version.

# Section 1

## ADVANCED OPERATIONS

---

Emergency Call function.....	1-2
◇ Assigning the Emergency Call function to [BANK OPT].....	1-2
◇ Setting the Emergency frequency .....	1-2
◇ Setting the Emergency alert volume .....	1-2
◇ Using the Emergency Call function .....	1-3
◇ Receiving an Emergency signal.....	1-4
Temporary Volume function .....	1-5
◇ Assigning the Temporary Volume function to [BANK OPT] .....	1-5
◇ Setting the Temporary Volume .....	1-5
◇ Using the Temporary Volume function.....	1-5

## 1. ADVANCED OPERATIONS

### Emergency Call function

The Emergency Call function is used when you are in an urgent situation.

When the function is ON, an Emergency signal is transmitted to let the other stations and people know that you require assistance, and an alarm sounds from the internal speaker.

You can also receive the Emergency signal from other stations.

#### ◇ Assigning the Emergency Call function to [BANK OPT]

1. While holding down [SET LOCK], hold down [⏏] for 1 second to enter the Initial Set mode.
2. Repeatedly push [SET LOCK] or [MONI ANM PA] to select "OK" ([BANK OPT] key).
3. Rotate [DIAL] to select "EMR."
4. Push [⏏] to save and exit the Initial Set mode.

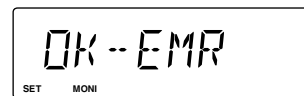

When "EMR" (Emergency) is selected in the [BANK OPT] key item.

#### ◇ Setting the Emergency frequency

1. While holding down [SET LOCK], hold down [⏏] for 1 second to enter the Initial Set mode.
2. Repeatedly push [SET LOCK] or [MONI ANM PA] to select "EM" (Emergency channel).
3. Rotate [DIAL] to select a channel.  
① Empty channels will not be displayed.
4. Push [⏏] to save and exit the Initial Set mode.

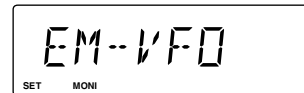

When "VFO" (VFO frequency) is selected in the Emergency channel item.

#### ◇ Setting the Emergency alert volume

1. While holding down [SET LOCK], hold down [⏏] for 1 second to enter the Initial Set mode.
2. Repeatedly push [SET LOCK] or [MONI ANM PA] to select "EV" (Emergency Alert volume).
3. Rotate [DIAL] to select the options.  
① See page 8-7 for details.
4. Push [⏏] to save and exit the Initial Set mode.

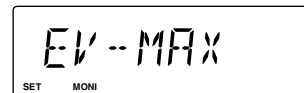

The Emergency Alert volume item

## 1. ADVANCED OPERATIONS

### Emergency Call function

#### ◇ Using the Emergency Call function

**IMPORTANT:** When another function is assigned to [BANK OPT], the Emergency Call function cannot be used.

1. Confirm that no Emergency signal is being received.
2. Hold down [BANK OPT] for 3 seconds until 6 short countdown beeps and 1 long beep sound.
  - The channel will change to the one set as an Emergency frequency, and an Emergency signal will be transmitted.
  - An Emergency alert sounds at the level set in the Emergency alert volume setting.
    - ① The alert and transmitting the signal last for 10 seconds.
3. After transmitting the Emergency signal, the audio from the surrounding area is automatically transmitted for 10 seconds, and you can explain your situation.
4. Wait for an answer signal.
  - ① You can also transmit an audio signal by holding down [PTT].
  - ① After 5 seconds have passed since receiving the signal, or no signal is received for 10 seconds, the transceiver will sound an Emergency alert and transmit an Emergency signal again.

**NOTE:** The countdown beeps and the long beep, the Emergency alert, and the received answer signal come from the internal speaker, speaker jack, or both, depends on the setting of AF output selection. See 8-8 for details.

#### TIP:

##### When the function is turned ON:

- All keys cannot be used except for [⏻] and [BANK OPT].
- The output power level is automatically set to "High." (When the function is turned OFF, it will be set back to the original power level.)
- The Weather Alert function will be turned OFF.
- When "MIN" is selected in the Emergency alert volume setting, the countdown beeps and the long beep, and the Emergency alert will not sound.

##### The Emergency signal cannot be transmitted when:

- The Emergency frequency is out of the selected amateur radio band.
- The transmission is inhibited due to high internal temperatures.

##### The Emergency signal can be transmitted, even if:

- The TX Inhibit setting is set to "Inhibit."
- The Repeater Lockout function is turned ON.
- The Time-out timer function is turned ON.

##### To turn OFF the Emergency Call function:

- Hold down [BANK OPT] for 3 seconds again.
- Turn OFF the transceiver, and then turn it ON again.

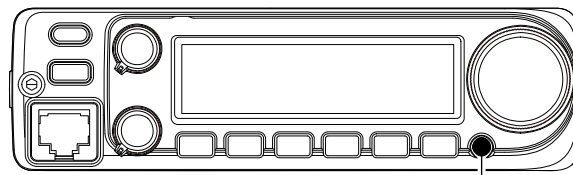

Hold down [BANK OPT] for 3 seconds.

#### When an Emergency signal is transmitted

Displayed The S/RF indicator is displayed.

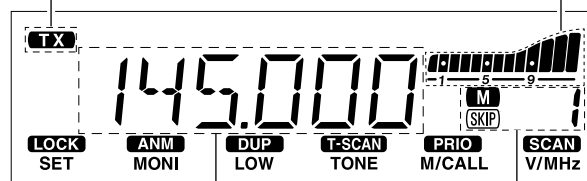

The Emergency frequency is displayed.

The Memory icon, Skip icon, and Memory channel number display will follow the channel set as the Emergency frequency.

## 1. ADVANCED OPERATIONS

### Emergency Call function

#### Using the HM-133V

1. Confirm that no Emergency signal is being received.
2. Hold down [BANK/OPTION] for 3 seconds until 6 short countdown beeps and 1 long beep sound.
  - The channel will change to the one set as an Emergency frequency, and an Emergency signal will be transmitted.
  - An Emergency alert sounds at the level set in the Emergency alert volume setting.
  - ① The alert and transmitting the signal last for 10 seconds.
3. After transmitting the Emergency signal, the audio from the surrounding area is automatically transmitted for 10 seconds, and you can explain your situation.
4. Wait for an answer signal.
  - ① You can also transmit an audio signal by holding down [PTT].
  - ① After 5 seconds have passed since receiving the signal, or no signal is received for 10 seconds, the transceiver will sound an Emergency alert and transmit an Emergency signal again.

**NOTE:** The countdown beeps and the long beep, the Emergency alert, and the received answer signal come from the internal speaker, speaker jack, or both, depends on the setting of AF output selection. See 8-8 for details.

#### ◇ Receiving an Emergency signal

##### When an Emergency signal is received:

- The received Emergency signal will sound at the level set in the Emergency alert volume setting.
- The function display blinks.
- If a scan is activated, it will stop.
- If the Priority watch is activated, it will stop in the operating mode that the signal is received.
- After receiving the signal, you can transmit an answer by holding down [PTT].

**NOTE:** Even if another function is assigned to [BANK OPT], the transceiver will receive an Emergency alert. However, the volume level will not change, and the function display will not blink.

##### TIP:

- When "MIN" is selected in the Emergency alert volume setting, the received Emergency signal will not sound.
- The Weather Alert function keeps being turned ON, even if an Emergency signal is received.
- If any operation is performed while receiving the signal, the volume level will be set back to the original level, and the function display blinking will be stopped.  
For the next 10 minutes, the volume level will not be changed, even if the signal is received again. Only the function display will blink.

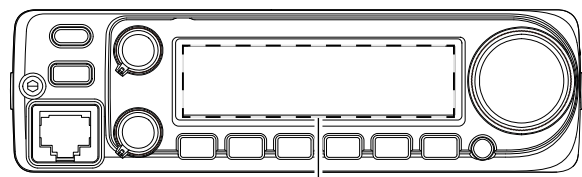
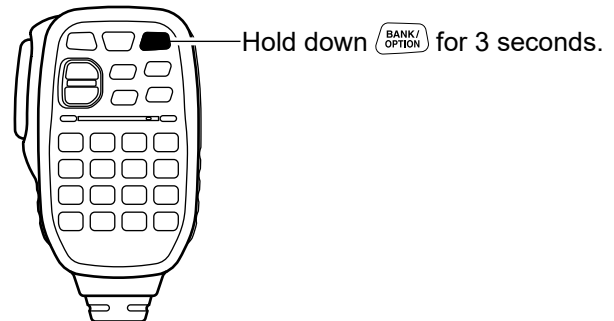

## 1. ADVANCED OPERATIONS

### Temporary Volume function

You can set a specific volume level between 0 and 32. Once [BANK OPT] is pushed, the volume level is changed to the set value.

#### ◇ Assigning the Temporary Volume function to [BANK OPT]

1. While holding down [SET LOCK], hold down [⓪] for 1 second to enter the Initial Set mode.
2. Repeatedly push [SET LOCK] or [MONI ANM PA] to select "OK" ([BANK OPT] key).
3. Rotate [DIAL] to select "TVo."
4. Push [⓪] to save and exit the Initial Set mode.



When "TVo" (Temporary Volume/Option) is selected in the [BANK OPT] key item.

#### ◇ Setting the Temporary Volume

1. While holding down [SET LOCK], hold down [⓪] for 1 second to enter the Initial Set mode.
2. Repeatedly push [SET LOCK] or [MONI ANM PA] to select "TV" (Temporary volume).
3. Rotate [DIAL] to set the volume level.
4. Push [⓪] to save and exit the Initial Set mode.

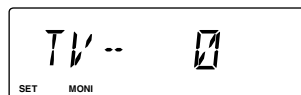

The Temporary volume item

**NOTE:** You can use the function as "One-Touch Mute" by setting volume at level 0.

#### ◇ Using the Temporary Volume function

**IMPORTANT:** When another function is assigned to [BANK OPT], this function cannot be used.

- Push [BANK OPT].
  - The volume level is changed to the set value.
  - "VOL" and the changed volume level is displayed.
- ① Push [BANK OPT] again to go back to the original level.
- ① To turn the function ON or OFF using the HM-133V, push [BANK/OPTION].

#### TIP: Changing the volume level when the function is turned ON

- When rotating [VOL], the function is turned OFF, and the volume level is changed to the value corresponding to the [VOL] level.
- When [VOL▲ 0 TONE-2] or [VOL▼ \* TONE-1] on the HM-133V is pushed, the function is turned OFF, and the volume level goes up or down from the set value.

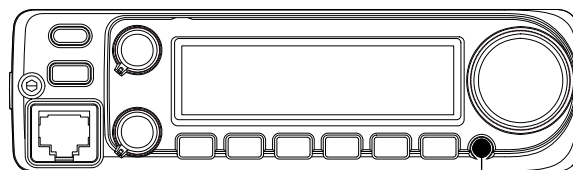

Push [BANK OPT].

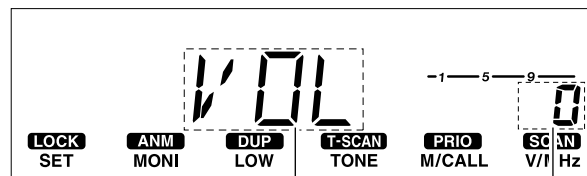

"VOL" is displayed.

The changed volume level is displayed.

## Section 2

## REPEATER OPERATION

---

FM Repeater operation.....	2-2
Accessing a repeater.....	2-2
◇ 1750 Hz tone (Using the HM-133V).....	2-3
Frequency Offset.....	2-4
Repeater Lockout.....	2-4
Reversed Duplex function.....	2-5
Auto Repeater function.....	2-5
◇ Setting the Auto Repeater function ON/OFF.....	2-5
◇ Frequency range and offset direction.....	2-5
Subaudible tones.....	2-6
◇ Tone information.....	2-6

## 2. REPEATER OPERATION

### FM Repeater operation

A Repeater receives signals on one frequency and then retransmits them on a different frequency. When using a Repeater, the transmit frequency is shifted from the receive frequency by a frequency offset.

A Repeater can be accessed using the Duplex function by setting the transceiver's offset to the same value as the Repeater's offset.

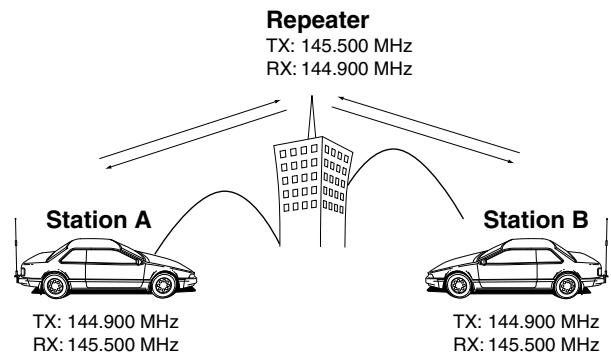

### Accessing a repeater

1. Set the receive frequency in the VFO mode.

**NOTE for only the USA version:**

When the Auto Repeater function is set to "R1," steps 2 and 3 are not necessary. When the function is set to "R2," steps 2 to 4 are not necessary. See page 8-5 for details.

2. Set the frequency offset in the Set mode.  
① See page 8-2 for details.
3. Hold down [LOW DUP] for 1 second once or twice to select the plus Duplex or the minus Duplex mode.
  - A "+" or "-" is displayed, depending on the frequency offset direction.
4. Repeatedly push [TONE T-SCAN] to turn ON the subaudible tone encoder, depending on the repeater requirements.
  - "♪" is displayed.
  - ① The 88.5 Hz tone frequency is set as the default. When a different tone frequency is needed to access a repeater, see page 2-6 for setting the tone frequency.
5. Hold down [PTT] to transmit.
  - The displayed frequency is automatically changed to the transmit frequency.
  - When "OFF" is displayed, confirm that the frequency offset is correctly set. (p. 8-2)
6. Release [PTT] to receive.
7. Push [MONI ANM PA] to check whether or not you can directly receive the signal from the other station.  
① The transmit frequency is displayed.
8. To return to the Simplex mode, hold down [LOW DUP] for 1 second once or twice.
  - A "-" or "+" disappears.
9. To turn OFF the subaudible tone encoder, repeatedly push [TONE T-SCAN] until "♪" disappears.

**Example: Select the minus Duplex mode, and then turn ON the subaudible tone encoder.**

Hold down [LOW DUP] for 1 second to select the minus Duplex mode.

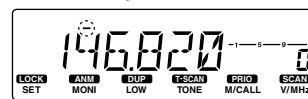

A "-" is displayed.

Repeatedly push [TONE T-SCAN] to turn ON the subaudible tone encoder.

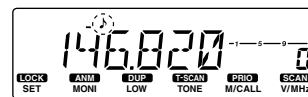

"♪" is displayed.

Hold down [PTT] to transmit.

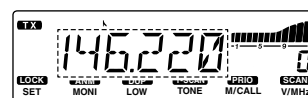

The displayed frequency is automatically changed to the transmit frequency.

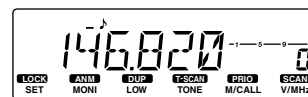

The frequency goes back to the receive frequency while receiving.

## 2. REPEATER OPERATION

### Accessing a repeater

#### Using the HM-133V

1. Set the receive frequency (repeater output frequency).
2. Set the frequency offset in the Set mode.
3. Push [DUP- 7 TONE] or [DUP+ 8 TSQL (T)] to select the minus Duplex or the plus Duplex mode.
  - A “+” or “-” is displayed.
4. Push [FUNC] then [DUP- 7 TONE] to turn ON the subaudible tone encoder, depending on the repeater requirements.
  - “♪” is displayed.
  - ① The 88.5 Hz tone frequency is set as the default. When a different tone frequency is needed to access a repeater, see page 2-6 for setting the tone frequency.
5. Hold down [PTT] to transmit.
  - The displayed frequency is automatically changed to the transmit frequency.
  - When “OFF” is displayed, confirm that the frequency offset is correctly set. (p. 8-2)
6. Release [PTT] to receive.
7. Push [MONI 1 ANM] to check whether or not you can directly receive the signal from the other station.
  - ① The transmit frequency is displayed.
8. Push [SIMP 9 TSQL] to return to the Simplex mode.
  - A “+” or “-” disappears.
9. To turn OFF the subaudible tone encoder, push [FUNC], and then [ENT C T-OFF].

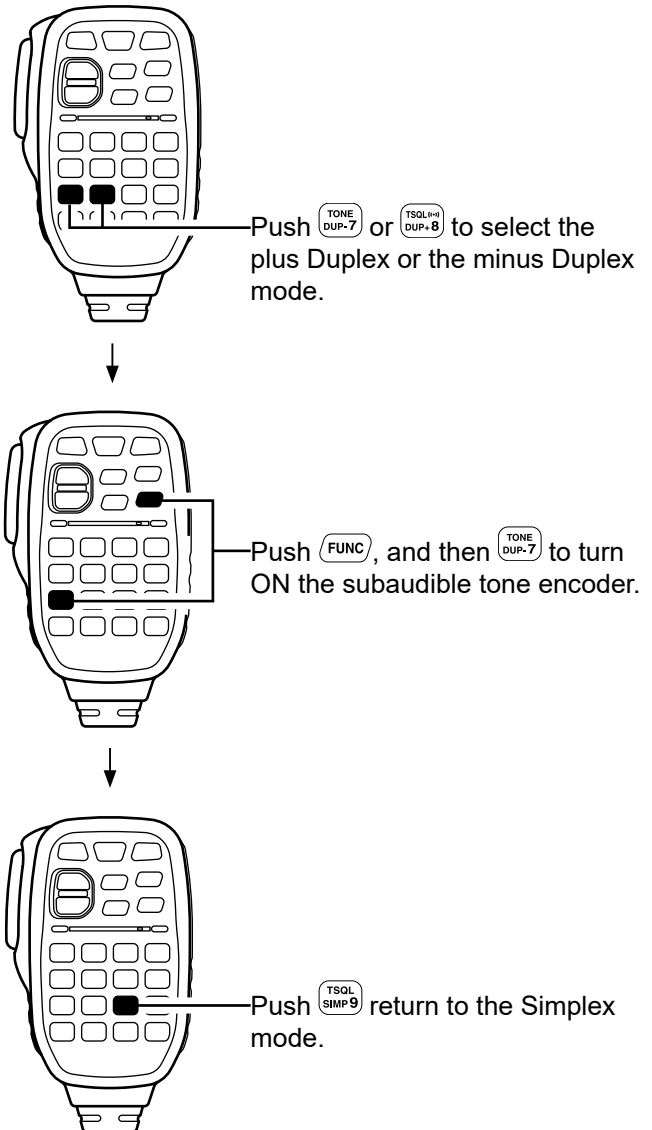

#### ◇ 1750 Hz tone (Using the HM-133V)

A 1750 Hz tone is required to access many European Repeaters.

##### To send a 1750 Hz tone for 1 second

- Push [FUNC], and then [VOL ▼ \* TONE-1].

##### To continuously send a 1750 Hz tone

- Push [FUNC], and then hold down [VOL ▲ 0 TONE-2].
- ① Release [VOL ▲ 0 TONE-2] to stop the transmission.

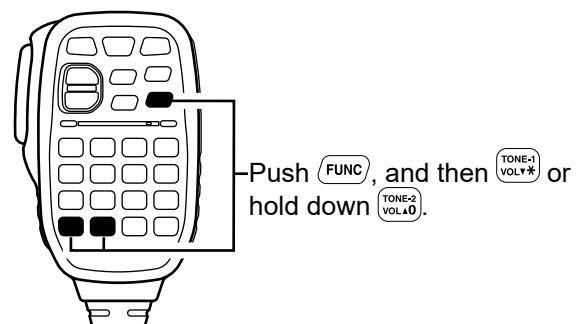

## 2. REPEATER OPERATION

### Frequency Offset

When communicating through a repeater, the transmit frequency is shifted up or down from the receive frequency.

1. Push [SET LOCK] to enter the Set mode.
2. Repeatedly push [SET LOCK] or [MONI ANM PA] until the “±” and the frequency offset are displayed.
3. Rotate [DIAL] to set the desired frequency offset.
  - Push [V/MHz SCAN] to change the frequency step between 1 kHz and 1 MHz.
4. Push any key other than [SET LOCK] or [MONI ANM PA] to save the selection and exit the Set mode.

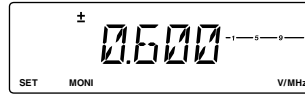

The Frequency offset item

#### Using the HM-133V

1. Push [SET B D-OFF] to enter the Set mode.
2. Repeatedly push [SET B D-OFF] or [ENT C T-OFF] until the “±” and the frequency offset are displayed.
3. Push [▲] or [▼] to set the desired offset.
  - The frequency cannot be directly entered using the keypad.
4. Push [CLR A MW] to save the selection and exit the Set mode.

### Repeater Lockout

This function helps prevent interference to other stations by inhibiting transmitting when a signal is received.

The transceiver has two inhibiting conditions, “RP” (repeater) and “BU” (busy).

1. Hold down [⏻] for 1 second to turn OFF the transceiver.
2. While holding down [SET LOCK], hold down [⏻] for 1 second to enter the Initial Set mode.
3. Repeatedly push [SET LOCK] or [MONI ANM PA] to select “RLO” (Repeater Lockout).
4. Rotate [DIAL] to set the Repeater Lockout function option to “RP,” “BU,” or “OF.”
  - “OF”: The Repeater Lockout function is OFF.
  - “RP”: Transmit is inhibited when a signal with an unmatched subaudible tone is received.
  - “BU”: Transmit is inhibited when a signal is received.
5. Push [⏻] to save and exit the Initial Set mode.

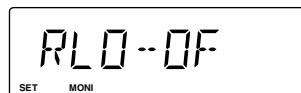
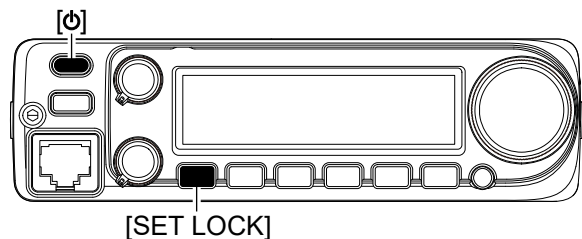

The Repeater Lockout item

## 2. REPEATER OPERATION

### Reversed Duplex function

When the Reversed Duplex function is ON, the receive frequency shifts. (The transmit frequency shifts in normal Duplex mode.) An example receive and transmit frequency are shown in the table below with the following settings:

Input frequency: 145.30 MHz  
 Offset direction: – (Negative)  
 Offset frequency: 0.6 MHz

Function	OFF	ON
RX frequency	145.30 MHz	144.70 MHz
TX frequency	144.70 MHz	145.30 MHz

1. Push [SET LOCK] to enter the Set mode.
2. Repeatedly push [SET LOCK] or [MONI ANM PA] to select “REV” (Reverse mode).
3. Rotate [DIAL] to turn the function ON or OFF.
4. Push any key other than [SET LOCK] or [MONI ANM PA] to save and exit the Set mode.

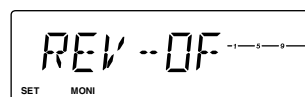

The Reversed mode item

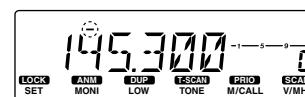

The duplex icon blinks when the function is ON.

#### Using the HM-133V

1. Push [SET B D-OFF] to enter the Set mode.
2. Repeatedly push [SET B D-OFF] or [ENT C T-OFF] to select “REV.”
3. Push [▲] or [▼] to turn the function ON or OFF.
4. Push [CLR A MW] to save and exit the Set mode.

### Auto Repeater function

**NOTE:** This function is only for the USA version.

The USA version automatically activates the repeater settings (DUP– or DUP+ and tone encoder ON/OFF) when the operating frequency falls within the general repeater output frequency range and deactivates them when outside of the range.

#### ◇ Setting the Auto Repeater function ON/OFF

1. Push [⓪] to turn OFF the transceiver.
2. While holding down [SET LOCK], hold down [⓪] for 1 second to enter the Initial Set mode.
3. Repeatedly push [SET LOCK] or [MONI ANM PA] to select “RPT” (Auto Repeater).
4. Rotate [DIAL] to select an option from “R1,” “R2,” or “OF.”
  - “OF”: The function is OFF.
  - “R1”: The function is ON, but the tone encoder is OFF.
  - “R2”: Both the function and tone encoder are ON.
5. Push [⓪] to exit the Initial Set mode.

#### ◇ Frequency range and offset direction

Frequency range	Duplex direction
145.200 ~ 145.495 MHz	A “-” is displayed.
146.610 ~ 146.995 MHz	A “-” is displayed.
147.000 ~ 147.395 MHz	A “+” is displayed.

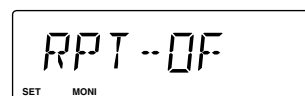

The Auto Repeater item

## 2. REPEATER OPERATION

### Subaudible tones

Some repeaters require subaudible tones to access. Subaudible tones are superimposed over your normal signal and must be set in advance.

1. Set the operating frequency.
2. Push [SET LOCK] to enter the Set mode.
3. Repeatedly push [SET LOCK] or [MONI ANM PA] to select “♪” and “rt” (Repeater Tone frequency).
4. Rotate [DIAL] to select the desired frequency.
5. Push any key other than [SET LOCK] or [MONI ANM PA] to save and exit the Set mode.

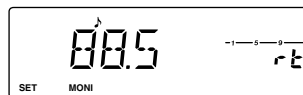

The Repeater Tone frequency item

#### Using the HM-133V

1. Set the operating frequency.  
① The subaudible tone frequency or code can be independently set for each Memory channel, Call channel, and the VFO mode.
2. Push [SET B D-OFF] to enter the Set mode.
3. Repeatedly push [SET B D-OFF] or [ENT C T-OFF] to select “♪” and “rt” (Repeater Tone frequency).
4. Push [▲] or [▼] to select the desired frequency.  
① Hold down [▲] or [▼] to sequentially change the frequencies.
5. Push [CLR A MW] to save and exit the Set mode.

#### Selectable Repeater Tone frequencies (unit: Hz)

67.0	79.7	94.8	110.9	131.8	156.7	171.3	186.2	203.5	229.1
69.3	82.5	97.4	114.8	136.5	159.8	173.8	189.9	206.5	233.6
71.9	85.4	100.0	118.8	141.3	162.2	177.3	192.8	210.7	241.8
74.4	88.5	103.5	123.0	146.2	165.5	179.9	196.6	218.1	250.3
77.0	91.5	107.2	127.3	151.4	167.9	183.5	199.5	225.7	254.1

#### ◇ Tone information

Some repeaters require a different tone system to be accessed.

#### DTMF codes

You can enter and transmit a DTMF code or manually transmit a DTMF tone.  
See pages 6-2 and 6-4 for details.

#### DTCS codes

The DTCS encoder superimposes the selected DTCS code over your transmitted signal.  
See page 7-8 for details.

① See the CTCSS tone or DTCS code. (p. 7-2)

#### NOTE:

- If you do not know the subaudible tone or DTCS code used for a repeater, the tone scan is convenient for detecting it. See page 7-7 for details.
- The subaudible tone frequency can be temporarily set in a Memory or Call channel. However, when another Memory channel or VFO mode is selected, the set frequency is deleted. To save the tone frequency, overwrite the channel setting.

## Section 3

## MEMORY OPERATION

---

General description .....	3-2
◇ Memory channel contents .....	3-2
Selecting a Memory channel .....	3-3
◇ Using the tuning dial.....	3-3
◇ Using [▲] or [▼] on the HM-133V.....	3-3
◇ Using the keypad on the HM-133V .....	3-3
Selecting a Call channel.....	3-4
Entering a Memory/Call channel .....	3-4
Copying the Memory channel contents .....	3-6
◇ Memory/Call channel to VFO .....	3-6
◇ Memory/Call channel to Call/Memory channel.....	3-7
Entering a channel name.....	3-8
Deleting a Memory channel.....	3-10
Setting a Memory Bank .....	3-11
Selecting a Memory Bank.....	3-13
Transferring a Memory channel to another bank.....	3-14
Deleting a Memory Bank .....	3-16

### 3. MEMORY OPERATION

## General description

The Memory mode enables you to quickly select often-used frequencies, modes, and other parameters. While operating in the Memory mode, you can temporarily change the operating frequency, mode, and so on without overwriting the Memory channel contents.

Group	Memory channel	Descriptions
000 to 199	000 to 199	Regular Memory channels. Up to 100 channels can be separately saved in the 10 Memory Banks.
Scan edge	1A/1B, 2A/2B, and 3A/3B	The upper and lower frequencies for the scanning range (3 pairs).
Call channel	C	Call channel for the FM band.

**NOTE:** Memory content may be accidentally cleared by static electricity, electric transients, and other causes. In addition, it may be cleared by a malfunction or during repairs. Therefore, we recommend that you backup the Memory channel contents or save it onto a PC.

① The CS-V3500 PROGRAMMING SOFTWARE can also be used to backup your Memory channel contents. See its instruction manual for details.

### ◇ Memory channel contents

- Operating frequency
- Operating mode
- Tuning step
- Transmit output power
- TX Inhibit function setting (p. 8-3)
- Duplex direction and offset
- Subaudible tone frequency, tone squelch frequency, or DTCS code with polarity
- Channel name
- Channel Name Display mode setting (p. 3-8)
- Skip setting\*

In addition, a total of 10 Memory Banks (A to J) are selectable for use by groups.

\* Except for Scan edge channels.

### 3. MEMORY OPERATION

## Selecting a Memory channel

**NOTE:** Only entered Memory channels can be selected.

#### ◇ Using the tuning dial

- Repeatedly push [M/CALL PRIO] to select the Memory mode.
  - “M” and the Memory channel number are displayed.
- Rotate [DIAL] to select a Memory channel.

#### ◇ Using [▲] or [▼] on the HM-133V

- Push [MR/CALL] to select the Memory mode.
  - “M” and the Memory channel number are displayed.
- Push [▲] or [▼] to select and set a Memory channel.

#### ◇ Using the keypad on the HM-133V

- Push [MR/CALL] to select the Memory mode.
  - “M” and the Memory channel number are displayed.
- Push [ENT C T-OFF].
  - “CH” is displayed.
- Push 3 numeric keys to input a channel number.
  - When a wrong number is input, push [ENT C T-OFF] to clear and re-enter from the 1st digit.
  - Push [CLR A MW] to cancel the input and return to the previous channel.
  - To select a Scan edge channel, push [1], [2], or [3], and then push [\*] or [#].  
“\*” and “#” can be used for “A” and “B” respectively.

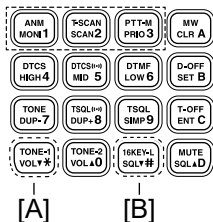

#### Example: Selecting Memory channel 2.

Repeatedly push [M/CALL PRIO] to select the Memory mode.

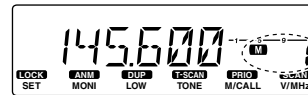

“M” and the Memory Channel number are displayed.

Rotate [DIAL] to select Memory channel 2.

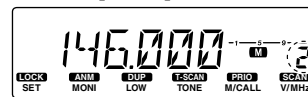

“2” is displayed.

#### Example: Selecting Memory channel 2.

Push [MR/CALL] to select the Memory mode.

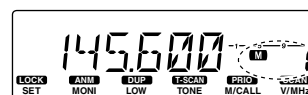

“M” and the Memory Channel number are displayed.

Push [▲] or [▼] to select Memory channel 2.

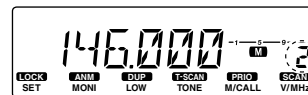

“2” is displayed.

#### Example: Selecting Memory channel 2.

Push [MR/CALL] to select the Memory mode.

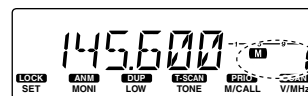

“M” and the Memory Channel number are displayed.

Push [ENT C T-OFF] to display “CH.”

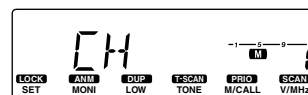

Push the 3 numeric keys (TONE-2 VOLA0 → TONE-2 VOLA0 → T-SCAN SCAN2).

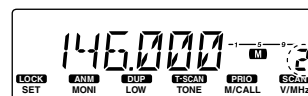

“2” is displayed.

### 3. MEMORY OPERATION

## Selecting a Call channel

The factory default frequency is entered in the Call channel.

- Repeatedly push [M/CALL PRIO] to select the Call channel.
  - A “C” is displayed.
- ① Push [M/CALL PRIO] again to select the Memory mode, or push [V/MHz SCAN] to select the VFO mode.

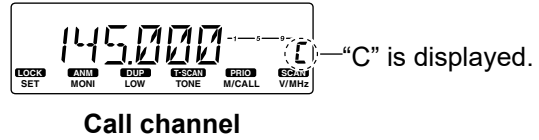

**NOTE:** When the VFO mode is selected from the Call channel, a small “c” is displayed instead of the Memory channel number.

### Using the HM-133V MICROPHONE

- Hold down [MR/CALL] for 1 second to select the Call channel.
  - ① Push [MR/CALL] to select the Memory mode, or push [VFO/LOCK] to select the VFO mode.

## Entering a Memory/Call channel

The VFO settings, including the Set mode contents, such as subaudible tone frequency and so on, can be entered into a Memory or Call channel.

1. Set the frequency in the VFO mode.
  - ① If desired, set other data (Example: frequency offset, duplex direction, and tone squelch).
2. Push [S.MW MW] to enter the Memory Write mode.
  - “M” and the Memory channel number blink.
3. Rotate [DIAL] to select a Memory or Call channel.
  - ① If the selected Memory channel is blank, only the Memory channel number is displayed.
4. Hold down [S.MW MW] for 1 second to write.
  - Three beeps sound.
  - ① The Memory channel number automatically increases when holding down [S.MW MW] after writing.

**NOTE:** You can also set a Memory channel in other ways.  
 Example: Entering the Memory contents to a different Memory channel or the Call channel.  
 (p. 3-7)

### Example: Entering 145.870 MHz to Memory channel 20.

Set the frequency in the VFO mode.

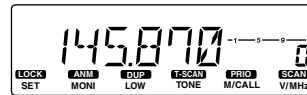

Push [S.MW MW] to enter the Memory Write mode.

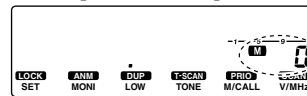

“M” and the Memory Channel number blink.

Rotate [DIAL] to select Memory channel 20.

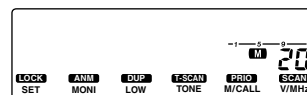

Hold down [S.MW MW] for 1 second to write.

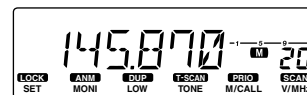

3 beeps sound.

### 3. MEMORY OPERATION

#### Entering a Memory/Call channel

##### Using the HM-133V MICROPHONE

1. Set the frequency in the VFO mode.
  - ① If desired, set other data (Example: frequency offset, duplex direction, and tone squelch).
2. Push [FUNC], and then push [CLR A MW].
  - “M” and the Memory channel number blink.
3. Push [▲] or [▼] to select a Memory or Call channel.
  - ① If the selected Memory channel is blank, only the Memory channel number is displayed.
4. Push [FUNC], and then hold down [CLR A MW] for 1 second to write.
  - Three beeps sound.
  - ① The Memory channel number automatically increases when holding down [CLR A MW] after writing.

##### Example: Entering 145.870 MHz to Memory channel 20.

Set the frequency in the VFO mode.

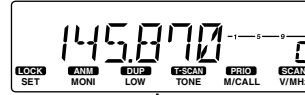

Push [FUNC], and then [MW CLR A] to enter the Memory Write mode.

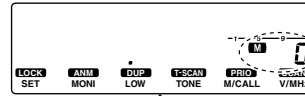

“M” and the Memory Channel number blink.

Push [▲] or [▼] to select Memory channel 20.

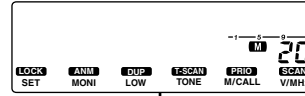

Push [FUNC], and then hold down [MW CLR A] for 1 second to write.

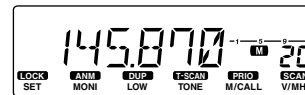

3 beeps sound.

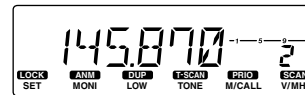

### 3. MEMORY OPERATION

## Copying the Memory channel contents

This function copies a Memory channel contents to the VFO, another Memory, or the Call channel. This function is used when searching for signals around the Memory channel frequency and for easy recalling the frequency offset, subaudible tone frequency, and so on.

### ◇ Memory/Call channel to VFO

1. Select the Memory or Call channel to be copied.
2. Hold down [S.MW MW] for 1 second to copy the selected Memory or Call channel contents to the VFO.
  - The VFO mode is automatically selected.

#### Example: Copying Memory channel 30 contents to the VFO.

Repeatedly push [M/CALL PRIO] to select the Memory mode.

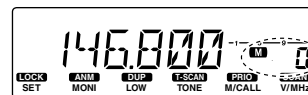

“M” and the Memory Channel number are displayed.

Rotate [DIAL] to select Memory channel 30.

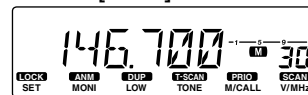

Hold down [S.MW MW] for 1 second to copy the Memory contents to the VFO.

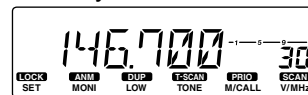

### Using the HM-133V MICROPHONE

1. Select the Memory or Call channel to be copied.
2. Push [FUNC], and then hold down [CLR A MW] for 1 second to copy the contents of the selected Memory or Call channel to the VFO.
  - The VFO mode is automatically selected.

#### Example: Copying Memory channel 30 contents to the VFO.

Push [MR/CALL] to select the Memory mode.

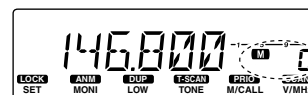

“M” and the Memory Channel number are displayed.

Push [▲] or [▼] to select Memory channel 30.

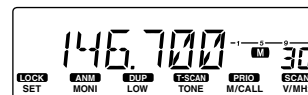

Push [FUNC], and then hold down [MW CLR A] for 1 second to copy the Memory contents to the VFO.

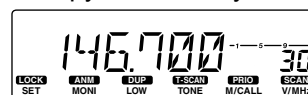

### 3. MEMORY OPERATION

#### Copying the Memory channel contents

#### ◇ Memory/Call channel to Call/Memory channel

1. Select the Memory or Call channel to be copied.
2. Push [S.MW MW] to enter the Memory Write mode.
  - “M” and “--” blink.
3. Rotate [DIAL] to select the target Memory or Call channel.
  - “C” blinks when the Call channel is selected.
  - ① The Scan edge channels can also be selected.
4. Hold down [S.MW MW] for 1 second to copy the contents to the target channel.
  - The targeted channel and the copied contents are displayed.

#### Example: Copying Memory channel 30 contents to channel 31.

Select Memory channel 30.

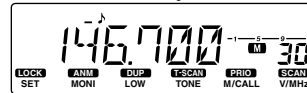

Push [S.MW MW] to enter the Memory Write mode.

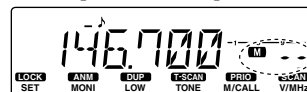

“M” and “--” blink.

Rotate [DIAL] to select Memory channel 31.

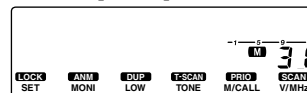

Hold down [S.MW MW] for 1 second to copy the contents.

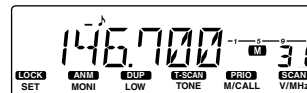

#### Using the HM-133V MICROPHONE

1. Select the Memory or Call channel to be copied.
2. Push [FUNC], and then push [CLR A MW] to enter the Memory Write mode.
  - “M” and “--” blink.
  - The VFO frequency is displayed.
3. Push [▲] or [▼] to select the target Memory or Call channel.
  - “C” blinks when the Call channel is selected.
  - ① The Scan edge channels can also be selected.
  - ① The keypad cannot be used for setting the channel.
4. Push [FUNC], and then hold down [CLR A MW] for 1 second to copy the contents to the target channel.
  - The target channel and the copied contents are displayed.

#### Example: Copying Memory channel 30 contents to channel 31.

Select Memory channel 30.

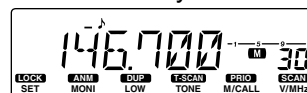

Push [FUNC], and then push [MW CLR A].

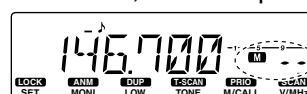

“M” and “--” blink.

Push [▲] or [▼] to select Memory channel 31.

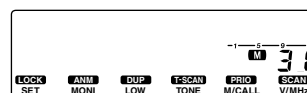

Push [FUNC], and then hold down [MW CLR A] for 1 second to copy the contents.

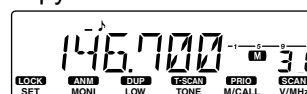

### 3. MEMORY OPERATION

## Entering a channel name

Each Memory and Call channel can be given an alphanumeric channel name for easy recognition.

- ① The maximum number of characters is 6.
- ② See the table below for the selectable characters.

1. Select the Memory or Call channel.
  2. Hold down [MONI ANM PA] for 1 second to enter the Channel Name Display mode.
    - Two beeps sound.
    - The name is displayed, if set.
  3. Push [SET LOCK] to enter the Channel Name Programming mode.
    - “-” blinks.
  4. Rotate [DIAL] to select a character.
    - The selected character blinks.
  5. Push [SET LOCK] or [MONI ANM PA] to move the cursor to the left or right.
  6. Repeat steps 4 and 5 until the channel name is completed.
  7. Push any key other than [SET LOCK] or [MONI ANM PA] to set the name.
    - After setting the name, exits the Channel Name Programming mode.
- ① To switch to the frequency display, hold down [MONI ANM PA] again for 1 second.

**NOTE:** When the Channel Name Display mode is selected and [SET LOCK] is pushed, you can always access the Channel Name Programming mode. To access the Set mode, exit the Channel Name Display mode by holding down [MONI ANM PA] for 1 second.

① When “NM” is selected in “DSP” (Display type) in the Initial Set mode, the channel name is displayed by the default. (p. 8-6)

#### • Selectable characters

P(A)	Q(B)	R(C)	S(D)	T(E)	U(F)	V(G)	W(H)	X(I)	Y(J)	Z(K)
L(L)	M(M)	N(N)	O(O)	P(P)	Q(Q)	R(R)	S(S)	T(T)	U(U)	V(V)
W(W)	X(X)	Y(Y)	Z(Z)	1(1)	2(2)	3(3)	4(4)	5(5)	6(6)	7(7)
8(8)	9(9)	0(0)	!(!)	"(")	##(#)	\$(%)	&(&)	'(')	!(!)	
!(!)	*(*)	+(+)	.(.)	--(-)	.\(.)	/(/)	:(:)	:(:)	<(<)	=(=)
>(>)	?(?)	@(@)	[([)	\(\)	]())	^(^)	(space)			

#### Example: Setting the name “CLUB” to Memory channel 5.

Select Memory channel 5.

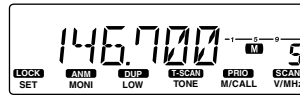

Hold down [MONI ANM PA] for 1 second to enter the Channel Name Display mode.

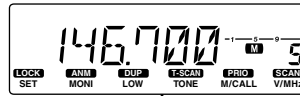

Two beeps sound.

Push [SET LOCK] to enter the Channel Name Programming mode.



“-” blinks.

Rotate [DIAL] to select “C.”



Push [MONI ANM PA] to move the cursor.

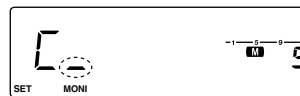

The next “-” blinks.

Repeat until the name is completely entered.

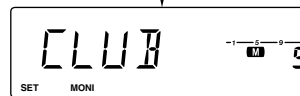

Push any key other than [SET LOCK] or [MONI ANM PA] to set the name.

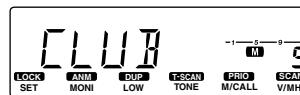

### 3. MEMORY OPERATION

#### Entering a channel name

##### Using the HM-133V MICROPHONE

1. Select the Memory or Call channel.
2. Push [FUNC], and then push [MONI 1 ANM] to enter the Channel Name Display mode.
  - The name is displayed, if set.
3. Push [SET B D-OFF] to enter the Channel Name Programming mode.
  - “-” blinks.
4. Push [▲] or [▼] to select a character.
  - The selected character blinks.
5. Push [SET B D-OFF] or [ENT C T-OFF] to move the cursor left or right.
6. Repeat steps 4 and 5 until the channel name is completed.
7. Push [CLR A MW] to set the name.
  - After setting the name, exits the Channel Name Programming mode.
  - To switch to the frequency display, push [FUNC] and then push [MONI 1 ANM].

##### Example: Setting a name “CLUB” to Memory channel 5.

Select Memory channel 5.

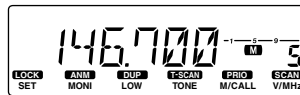

Push [FUNC], and then [ANM MONI 1] to enter the Channel Name Display mode.

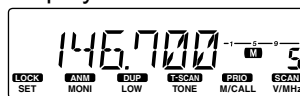

Two beeps sound.

Push [D-OFF SET B] to enter the Channel Name Programming mode.

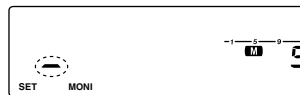

“-” blinks.

Push [▲] or [▼] to select “C.”

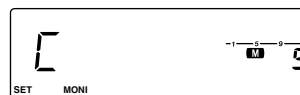

Push [D-OFF SET B] to move the cursor.



The next “-” blinks.

Repeat until the name is completely entered.

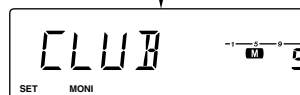

Push [MW CLR A] to set the name.

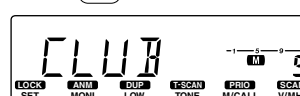

### 3. MEMORY OPERATION

## Deleting a Memory channel

You can delete Memory channel contents.

**NOTE:** The deleted Memory channel contents cannot be recalled.

1. Push [V/MHz SCAN] to select the VFO mode.
2. Push [S.MW MW] to enter the Memory Write mode.
  - “M” and the Memory channel number blink.
3. Rotate [DIAL] to select the Memory channel.
  - ① Memory channels not set are blank.
4. Push [S.MW MW], and then sequentially hold down [S.MW MW] for 1 second to delete the contents.

**NOTE:** This operation must be performed within 1.5 seconds.

- Three beeps sound, and then the selected Memory channel contents are deleted.
  - ① When the Call channel is deleted, the current VFO contents are automatically reassigned to the Call channel.
5. Push any key other than [S.MW MW] to return to the VFO mode.

### Using the HM-133V MICROPHONE

1. Push [VFO/LOCK] to select the VFO mode.
2. Push [FUNC], and then push [CLR A MW] to enter the Memory Write mode.
3. Push [▲] or [▼] to select the Memory channel.
  - “M” and the Memory channel number blink.
  - ① Memory channels not set are blank.
4. Push [FUNC] then [CLR A MW], and then push [FUNC] then hold down [CLR A MW] for 1 second to delete the contents.

**NOTE:** This operation must be performed within 1.5 seconds.

- Three beeps sound, and then the selected Memory channel contents are deleted.
  - ① When the Call channel is deleted, the current VFO contents are automatically reassigned to the Call channel.
5. Push [CLR A MW] to return to the VFO mode.

### Example: Deleting Memory channel 20.

Push [V/MHz SCAN] to select the VFO mode.

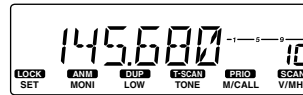

Push [S.MW MW] to enter the Memory Write mode.

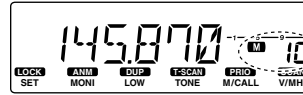

“M” and the Memory Channel number blink.

Rotate [DIAL] to select Memory channel 20.

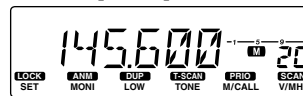

Push [S.MW MW], and then sequentially hold down [S.MW MW] for 1 second to delete the contents.

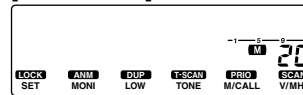

Push any key other than [S.MW MW] to return to the VFO mode.

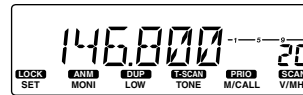

### Example: Deleting Memory channel 20.

Push [VFO/LOCK] to select the VFO mode.

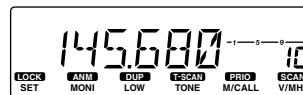

Push [FUNC], and then [MW CLR A] to enter the Memory Write mode.

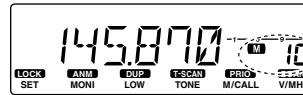

“M” and the Memory Channel number blink.

Push [▲] or [▼] to select Memory channel 20.

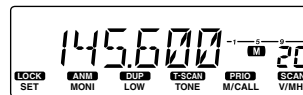

Push [FUNC] then [MW CLR A], and push [FUNC] then hold down [MW CLR A] for 1 second within 1.5 seconds to delete the contents.

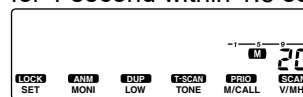

Push [MW CLR A] to return to the VFO mode.

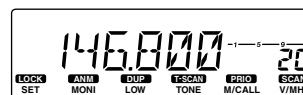

### 3. MEMORY OPERATION

## Setting a Memory Bank

The transceiver has a total of 10 banks (A ~ J). Regular Memory channels 000 ~ 199 and the Scan edge channels 1A/1B, 2A/2B, and 3A/3B can be assigned to any bank for easy Memory management. Up to 100 channels can be assigned to a bank. Categorizing Memory channels according to their types or purposes using Memory Banks is convenient. You can also use the Memory Bank scan function. (pp. 4-6, 4-8)

1. Select the Memory channel to be assigned to the bank.
2. Push [SET LOCK] to enter the Set mode.
3. Repeatedly push [SET LOCK] or [MONI ANM PA] to select "BAK" (Bank setting).
4. Rotate [DIAL] to select the bank.
5. Push any key other than [SET LOCK] or [MONI ANM PA] to save and exit the Set mode.

#### NOTE:

- The banks are only used to hold Memory channels. Therefore, if the original Memory channel content has been changed, the Memory Bank content is also changed at the same time.
- To use banks, "BAK" (Bank/Option) must be assigned to [BANK OPT]. See page 8-6 for details.

#### Example: Setting Memory channel 1 to Bank A.

Select Memory channel 1.

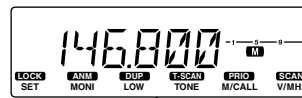

Push [SET LOCK] to enter the Set mode.

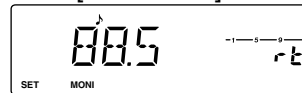

Repeatedly push [SET LOCK] or [MONI ANM] to select "BAK."

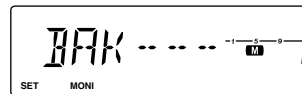

Rotate [DIAL] to select Bank A.

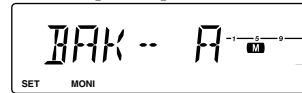

Push any key other than [SET LOCK] or [MONI ANM PA] to save and exit the Set mode.

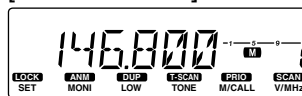

### 3. MEMORY OPERATION

#### Setting a Memory Bank

##### Using the HM-133V MICROPHONE

1. Select the Memory channel to be assigned to the bank.
2. Push [SET B D-OFF] to enter the Set mode.
3. Repeatedly push [SET B D-OFF] or [ENT C T-OFF] to select "BAK" (Bank setting).
  - "--" blinks.
4. Push [▲] or [▼] to select the bank.
5. Push [CLR A MW] to save and exit the Set mode.

##### Example: Setting Memory channel 1 to Bank A.

Select Memory channel 1.

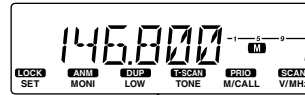

Push [D-OFF SET B] to enter the Set mode.

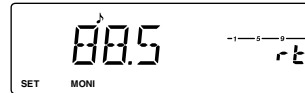

Repeatedly push [D-OFF SET B] or [T-OFF ENT C] to select to select "BAK."

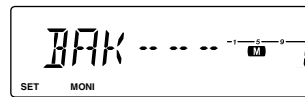

Push [▲] or [▼] to select Bank A.

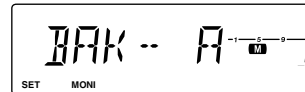

Push [MW CLR A] to save and exit the Set mode.

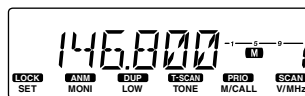

### 3. MEMORY OPERATION

## Selecting a Memory Bank

- Repeatedly push [M/CALL PRIO] to select the Memory mode.
  - “M” and the Memory Channel number are displayed.
- Push [BANK OPT] to select the Memory Bank mode.
  - “M” and the bank letter blink.
  - ① The bank name is displayed, if set.
- Rotate [DIAL] to select the desired bank.
  - ① Banks that contain no Memory channels are skipped.
- Push any key to exit the Memory Bank mode.
  - “M” and the bank letter are displayed.
- Rotate [DIAL] to select the Memory channel in the bank.
  - ① The Memory channel number is not displayed.
- To return to the Memory mode, push [BANK OPT] twice.

### Example: Selecting Memory Bank A.

Repeatedly push [M/CALL PRIO] to select the Memory mode.

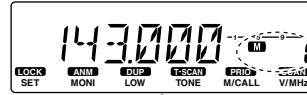

“M” and the Memory Channel number are displayed.

Push [BANK OPT] to enter the Memory Bank mode.

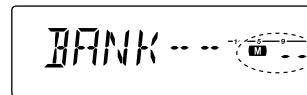

“M” and the bank letter blink.

Rotate [DIAL] to select Bank A.



Push any key to exit the Memory Bank mode.

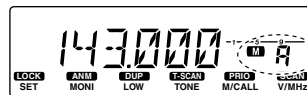

“M” and the bank letter are displayed.

### Using the HM-133V MICROPHONE

- Push [MR/CALL] to select the Memory mode.
  - “M” and the Memory Channel number are displayed.
- Push [BANK/OPTION] to select the Memory Bank mode.
  - “M” and the bank letter blink.
  - ① The bank name is displayed, if set.
- Push [▲] or [▼] to select the desired bank.
  - ① Banks that contain no Memory channels are skipped.
- Push [CLR A MW] to exit the Memory Bank mode.
  - “M” and the bank letter are displayed.
- Push [▲] or [▼] to select the Memory channel in the bank.
  - ① The Memory channel number is not displayed.
- To return to the Memory mode, push [BANK/OPTION], and then push [CLR A MW].

### Example: Selecting Memory Bank A.

Push to select the Memory mode.

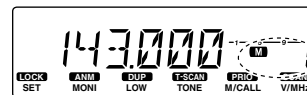

“M” and the Memory Channel number are displayed.

Push to enter the Memory Bank mode.

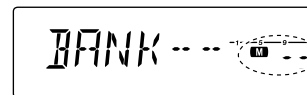

“M” and the bank letter blink.

Push or to select Bank A.

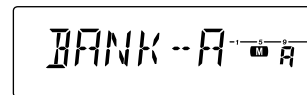

Push to exit the Memory Bank mode.

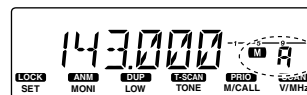

“M” and the bank letter are displayed.

### 3. MEMORY OPERATION

## Transferring a Memory channel to another bank

The Memory channel in the bank can be transferred to another bank.

1. Repeatedly push [M/CALL PRIO] to select the Memory mode.
  - “M” and the Memory channel number are displayed.
2. Push [BANK OPT] to select the Memory Bank mode.
  - “M” and the bank letter blink.
  - ① The bank name is displayed, if set.
3. Rotate [DIAL] to select the bank.
  - ① Banks that contain no Memory channels are skipped.
4. Push any key to exit the Memory Bank mode.
  - “M” and the bank letter are displayed.
5. Rotate [DIAL] to select the Memory channel to transfer.
  - ① The Memory channel number is not displayed.
6. Push [SET LOCK] to enter the Set mode.
7. Repeatedly push [SET LOCK] or [MONI ANM PA] to select “BAK” (Bank setting).
8. Rotate [DIAL] to select the destination bank.
9. Push any key other than [SET LOCK] or [MONI ANM PA] to save and exit the Set mode.
  - The transferred channel is displayed in the destination bank.

### Example: Transferring from Bank A to C.

Repeatedly push [M/CALL PRIO] to select the Memory mode.



Push [BANK OPT] to select the Memory Bank mode.

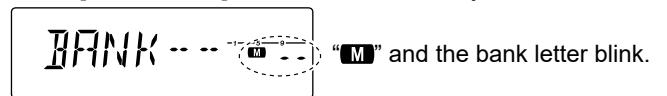

Rotate [DIAL] to select the Memory Bank A.

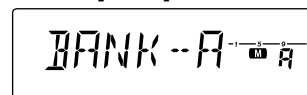

Push any key to exit the Memory Bank mode.



Rotate [DIAL] to select the Memory channel to transfer.

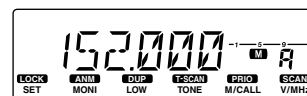

Push [SET LOCK] to enter the Set mode.

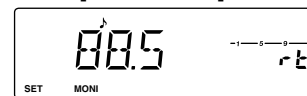

Repeatedly push [SET LOCK] or [MONI ANM PA] to select “BAK.”

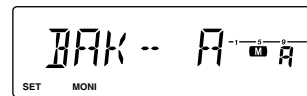

Rotate [DIAL] to select Bank C.

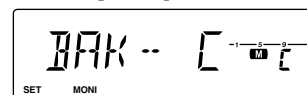

Push any key other than [SET LOCK] or [MONI ANM PA] to save and exit the Set mode.

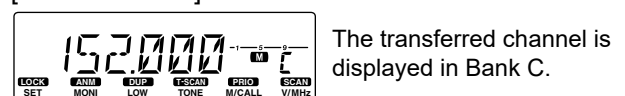

### 3. MEMORY OPERATION

#### Transferring a Memory channel to another bank

##### Using the HM-133V MICROPHONE

1. Push [MR/CALL] to select the Memory mode.
  - “M” and the Memory channel number are displayed.
2. Push [BANK/OPTION] to select the Memory Bank mode.
  - “M” and the bank letter blink.
  - ① The bank name is displayed, if set.
3. Push [▲] or [▼] to select the bank.
  - ① Banks that contain no Memory channels are skipped.
4. Push [CLR A MW] to exit the Memory Bank mode.
  - “M” and the bank letter are displayed.
5. Push [▲] or [▼] to select the Memory channel to transfer.
  - ① The Memory channel number is not displayed.
6. Push [SET B D-OFF] to enter the Set mode.
7. Repeatedly push [SET B D-OFF] or [ENT C T-OFF] to select “BAK” (Bank setting).
8. Push [▲] or [▼] to select the destination bank.
9. Push [CLR A MW] to save and exit the Set mode.
  - The transferred channel is displayed in the destination bank.

##### Example: Transferring from Bank A to C.

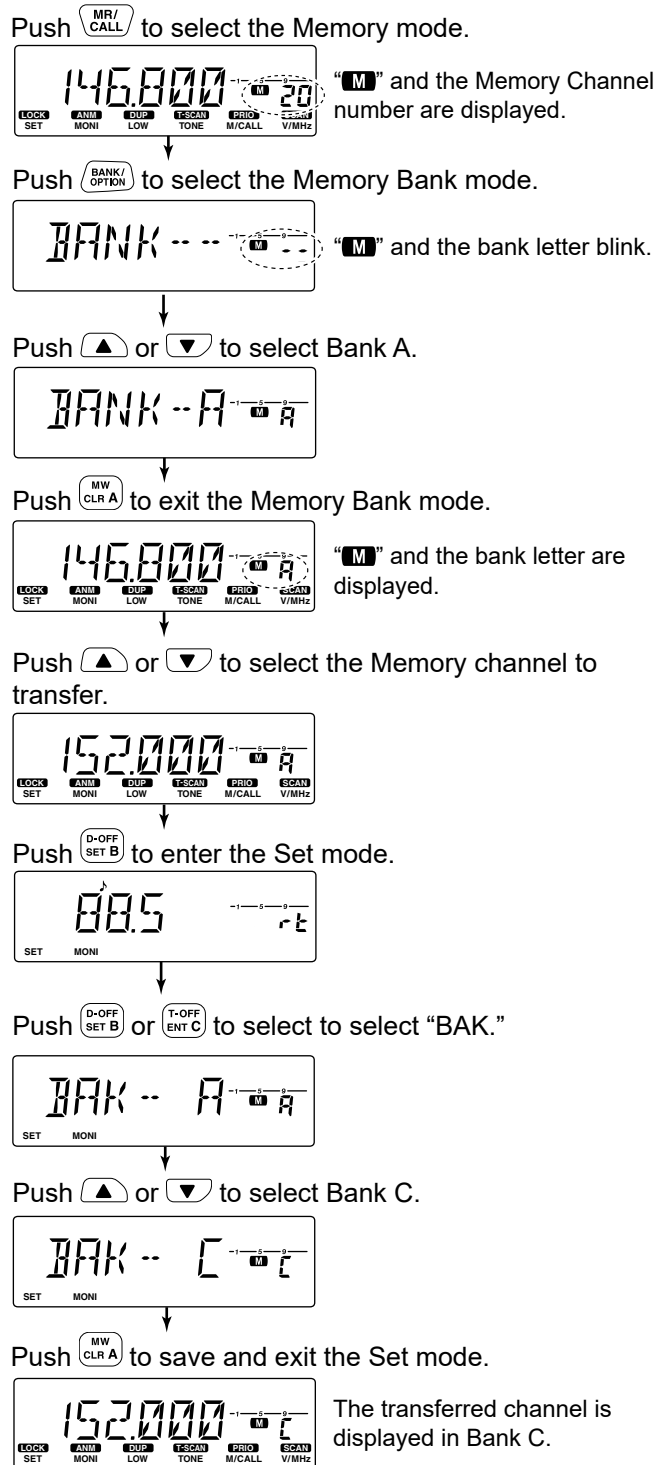

### 3. MEMORY OPERATION

## Deleting a Memory Bank

You can delete the desired bank.

**NOTE:** Even if a bank is deleted, the Memory channel contents remain.

1. Repeatedly push [M/CALL PRIO] to select the Memory mode.
  - “M” and the Memory channel number are displayed.
2. Push [BANK OPT] to select the Memory Bank mode.
  - “M” and the bank letter blink.
  - ① The bank name is displayed, if set.
3. Rotate [DIAL] to select the bank.
  - ① Banks that contain no Memory channels are skipped.
4. Push any key to exit the Memory Bank mode.
  - “M” and the bank letter are displayed.
5. Rotate [DIAL] to select the Memory channel to transfer.
  - ① The Memory channel number is not displayed.
6. Push [SET LOCK] to enter the Set mode.
7. Repeatedly push [SET LOCK] or [MONI ANM PA] to select “BAK” (Bank setting).
8. Rotate [DIAL] to select “-- --.”
9. Push any key other than [SET LOCK] or [MONI ANM PA] to delete the link and exit the Set mode.
  - The selected bank is deleted and the Memory mode is automatically selected.

### Example: Deleting Bank A.

Repeatedly push [M/CALL PRIO] to select the Memory mode.



Push [BANK OPT] to select the Memory Bank mode.

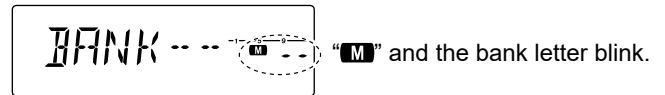

Rotate [DIAL] to select Bank A.



Push any key to exit the Memory Bank mode.



Push [SET LOCK] to enter the Set mode.

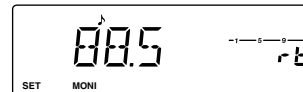

Repeatedly push [SET LOCK] or [MONI ANM] to select “BAK.”

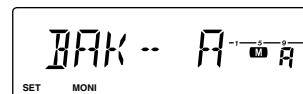

Rotate [DIAL] to select “-- --.”

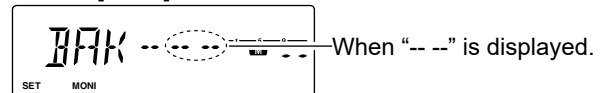

Push any key other than [SET LOCK] or [MONI ANM PA] to save and exit the Set mode.

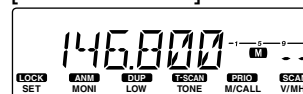

### 3. MEMORY OPERATION

#### Deleting a Memory Bank

##### Using the HM-133V MICROPHONE

1. Push [MR/CALL] to select the Memory mode.
  - “M” and the Memory channel number are displayed.
2. Push [BANK/OPTION] to select the Memory Bank mode.
  - “M” and the bank letter blink.
  - ① The bank name is displayed, if set.
3. Push [▲] or [▼] to select the bank.
  - ① Banks that contain no Memory channels are skipped.
4. Push [CLR A MW] to exit the Memory Bank mode.
  - “M” and the bank letter are displayed.
5. Push [▲] or [▼] to select the Memory channel to transfer.
  - ① The Memory channel number is not displayed.
6. Push [SET B D-OFF] to enter the Set mode.
7. Repeatedly push [SET B D-OFF] or [ENT C T-OFF] to select “BAK” (Bank setting).
8. Push [▲] or [▼] to select “-- --.”
9. Push [CLR A MW] to delete the link and exit the Set mode.

##### Example: Deleting Bank A.

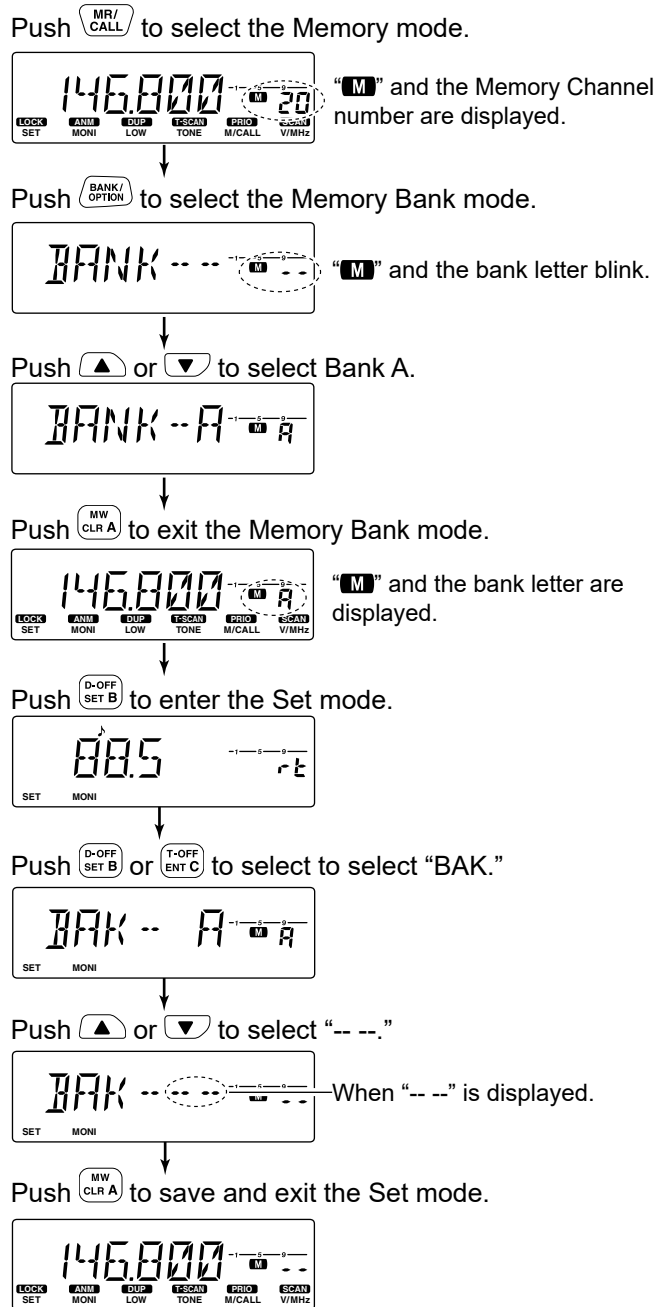

## Section 4      SCAN OPERATION

---

About scans.....	4-2
◇ VFO scan .....	4-2
◇ Memory scan.....	4-2
◇ Memory Bank scan.....	4-2
◇ [DIAL] operation during a scan.....	4-3
◇ Squelch setting for a scan .....	4-3
◇ Tuning step for a VFO scan .....	4-3
◇ Skip function.....	4-3
◇ When a signal is received .....	4-3
VFO scan.....	4-4
Memory scan .....	4-5
Memory Bank scan.....	4-6
◇ Bank scan.....	4-6
◇ Bank Link scan .....	4-8
Entering Scan Edges.....	4-10
Setting a Skip channel.....	4-11

## 4. SCAN OPERATION

### About scans

Scanning is a versatile function that can automatically search for signals. A scan makes it easier to locate stations to contact, or listen to or to skip unwanted channels or frequencies.

#### ◇ VFO scan

The VFO scan searches for signals in the entire band, or the specified frequency range.

##### Full scan

Repeatedly searches the entire band.

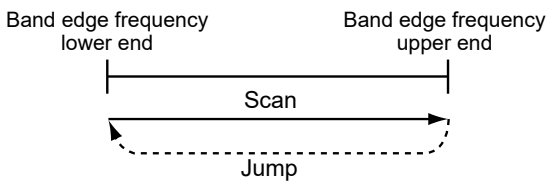

##### Programmed scan

Repeatedly searches between 2 Program Scan Edges.

① Three pairs of Scan Edges (1A/1B, 2A/2B, 3A/3B) can be used.

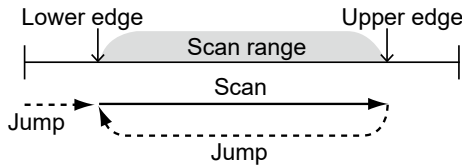

#### ◇ Memory scan

The Memory scan searches signals on all entered Memory channels.

##### Full Memory scan

Repeatedly searches all entered Memory channels.

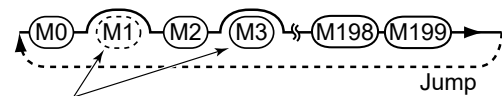

Empty channels and the channels set as Skip channels are skipped.

#### ◇ Memory Bank scan

##### Bank scan

Repeatedly searches the Memory channels in the selected bank.

Example: BANK A (M0 to M5 are included)

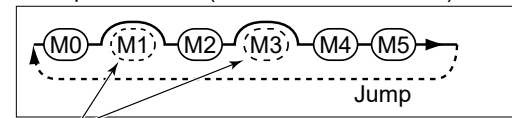

The channels set as Skip channels are skipped.

##### Bank Link scan

Repeatedly searches the linked banks. (p. 4-8)

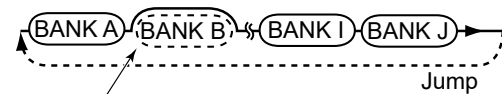

The banks that are not linked are skipped.

#### Tone scan

The Tone scan searches for tone frequencies or DTCS codes used by stations using the Tone Squelch function. See page 7-7 for details.

① A Tone scan is usable in any VFO, Memory, or Call channel mode.

① During a scan, rotate [DIAL] to change the scan direction.

## 4. SCAN OPERATION

### About scans

#### ◇ [DIAL] operation during a scan

- Rotate [DIAL] to change the scan direction during a scan.
- When the scan is paused, rotate [DIAL] to resume the scan.

#### ◇ Squelch setting for a scan

You can change the squelch level to suit your operating needs. Set the squelch level to open the squelch, according to the received signal strength. During a scan, rotate [SQL] to adjust the squelch level.

#### ◇ Tuning step for a VFO scan

The selected tuning step is applied to the scan. For a Full scan and Programmed scan, set the tuning step. See the Basic manual for details.

#### ◇ Skip function

The Skip function speeds up scanning by not scanning Memory channels set as Skip channels. (p. 4-11)

#### ◇ When a signal is received

When a signal is received, the scan pauses for approximately 10 seconds (default). The scan resumes approximately 2 seconds (default) after the signal disappears. To manually resume the scan, rotate [DIAL]. These settings can be changed in the Set mode. (p. 8-3)

#### Example: When receiving a signal during a Full scan.

The S/Rf indicator displays the received signal strength.

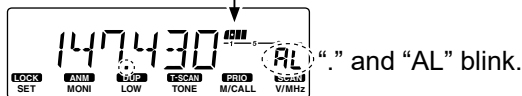

## 4. SCAN OPERATION

### VFO scan

1. Push [V/MHz SCAN] to select the VFO mode.
2. Set the squelch to the point where the noise just disappears.
3. Hold down [V/MHz SCAN] for 1 second to start scanning.
  - The frequency decimal point and the selected scan type icon blink.
  - ① When a signal is detected, the scan pauses according to the Scan Stop timer setting, and then resumes.
  - ② Push [MONI ANM PA] to stop or resume the scan.
4. Push [V/MHz SCAN] to cancel the scan.

**TIP:**

- During a scan, rotating [DIAL] changes the scanning direction.
- Push [SET LOCK] to switch between a Full scan and a Programmed scan (P1, P2, or P3).
  - ① P1, P2, or P3 can be selected only when their Program Scan Edges are entered.

### Using the HM-133V MICROPHONE

1. Push [VFO/LOCK] to select the VFO mode.
2. Set the squelch to the point where the noise just disappears.
3. Push [SCAN 2 T-SCAN] to start scanning.
  - The frequency decimal point and the selected scan type icon blink.
  - ① When a signal is detected, the scan pauses according to the Scan Stop timer setting, and then resumes.
  - ② Push [MONI 1 ANM] to stop or resume the scan.
4. Push [SCAN 2 T-SCAN] to cancel the scan.

**TIP:**

- You can also start scanning by holding down [▲] or [▼] for 1 second.
- Push [SET B D-OFF] to switch between a Full scan and a Programmed scan (P1, P2, or P3).

#### Example: Starting a Full scan.

Push [V/MHz SCAN] to select the VFO mode.

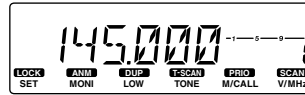

Hold down [V/MHz SCAN] for 1 second to start scanning.

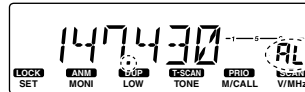

“.” and “AL” blink.

#### Example: Starting a Full scan.

Push [VFO/LOCK].

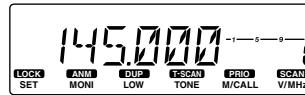

Push [T-SCAN SCAN2].

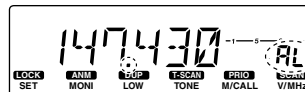

“.” and “AL” blink.

## 4. SCAN OPERATION

### Memory scan

**NOTE:** Two or more Memory channels, which are not set as Skip channels, must be entered to start a Full Memory scan.

1. Repeatedly push [M/CALL PRIO] to select the Memory mode.
2. Set the squelch to the point where the noise just disappears.
3. Hold down [V/MHz SCAN] for 1 second to start scanning.
  - The frequency decimal point and “M” blink.
  - ① When a signal is detected, the scan pauses according to the Scan Stop timer setting, and then resumes.
  - ② Push [MONI ANM PA] to stop or resume the scan.
4. Push [V/MHz SCAN] to cancel the scan.

**TIP:** During a scan, rotating [DIAL] changes the scanning direction.

#### Using the HM-133V MICROPHONE

1. Push [MR/CALL] to select the Memory mode.
2. Set the squelch to the point where the noise just disappears.
3. Push [SCAN 2 T-SCAN] to start scanning.
  - The frequency decimal point and “M” blink.
  - ① When a signal is detected, the scan pauses according to the Scan Stop timer setting, and then resumes.
  - ② Push [MONI 1 ANM] to stop or resume the scan.
4. Push [SCAN 2 T-SCAN] to cancel the scan.

**TIP:** You can also start scanning by holding down [▲] or [▼] for 1 second.

#### Example: Starting a Full Memory scan.

Repeatedly push [M/CALL PRIO] to select the Memory mode.

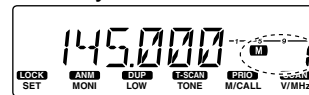

“M” and the Memory Channel number are displayed.

Hold down [V/MHz SCAN] for 1 second to start scanning.

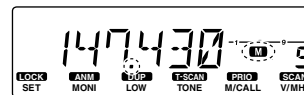

“.” and “M” blink.

#### Example: Starting a Full Memory scan.

Push [MR/CALL] to select the Memory mode.

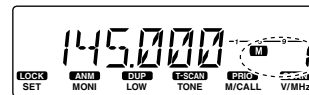

“M” and the Memory Channel number are displayed.

Push [SCAN 2 T-SCAN] to start scanning.

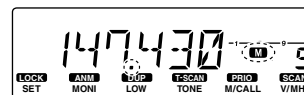

“.” and “M” blink.

## 4. SCAN OPERATION

# Memory Bank scan

### ◇ Bank scan

A Bank scan searches through the Memory channels in the selected bank.

① Two or more Memory channels, which are not set as skip channels, must be entered to start a Memory Bank scan.

1. Repeatedly push [M/CALL PRIO] to select the Memory mode.
  - “M” and the Memory Channel number are displayed.
2. Push [BANK OPT] to select the Memory Bank mode.
  - “M” and the bank letter blink.
  - ① The bank name is displayed, if set.
3. Rotate [DIAL] to select the desired bank.
  - ① Banks that contain no Memory channels are skipped.
4. Push any key to exit the Memory Bank mode.
  - “M” and the bank letter are displayed.
5. Hold down [V/MHz SCAN] for 1 second to start scanning.
  - The frequency decimal point and “M” blink.
  - ① When a signal is detected, the scan pauses according to the Scan Stop timer setting, and then resumes.
  - ① Push [MONI PAANM] to stop or resume the scan.
6. Push [V/MHz SCAN] to cancel the scan.

**TIP:** During a scan, rotating [DIAL] changes the scanning direction.

### Example: Starting a Bank scan in Bank A.

Repeatedly push [M/CALL PRIO] to select the Memory mode.

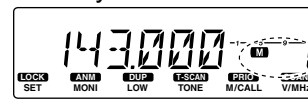

“M” and the Memory Channel number are displayed.

Push [BANK OPT] to enter the Memory Bank mode.

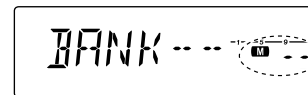

“M” and the bank letter blink.

Rotate [DIAL] to select Bank A.



Push any key to exit the Memory Bank mode.

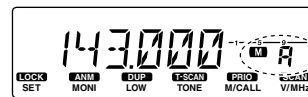

“M” and the bank letter are displayed.

Hold down [V/MHz SCAN] for 1 second to start scanning.

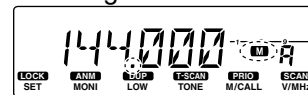

“.” and “M” blink.

## 4. SCAN OPERATION

### Memory Bank scan

#### Using the HM-133V MICROPHONE

1. Push [MR/CALL] to select the Memory mode.
  - “M” and the Memory Channel number are displayed.
2. Push [BANK/OPTION] to select the Memory Bank mode.
  - “M” and the bank letter blink.
  - ① The bank name is displayed, if set.
3. Push [▲] or [▼] to select the desired bank.
  - ① Banks that contain no Memory channels are skipped.
4. Push [CLR A MW] to exit the Memory Bank mode.
  - “M” and the bank letter are displayed.
5. Push [SCAN 2 T-SCAN] to start scanning.
  - The frequency decimal point and “M” blink.
  - ① When a signal is detected, the scan pauses according to the Scan Stop timer setting, and then resumes.
  - ① Push [MONI 1 ANM] to stop or resume the scan.
6. Push [SCAN 2 T-SCAN] to cancel the scan.

**TIP:** You can also start scanning by holding down [▲] or [▼] for 1 second.

#### Example: Starting a Bank scan in Bank A.

Push [MR/CALL] to select the Memory mode.

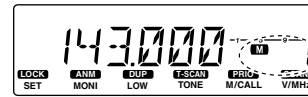

“M” and the Memory Channel number are displayed.

Push [BANK/OPTION] to enter the Memory Bank mode.

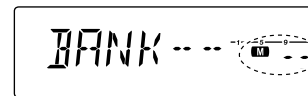

“M” and the bank letter blink.

Push [▲] or [▼] to select the bank. (Example: Bank A)

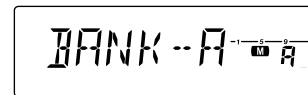

Push [MW CLR A] to exit the Memory Bank mode.

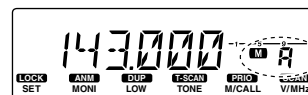

“M” and the bank letter are displayed.

Push [T-SCAN SCAN2] to start scanning.

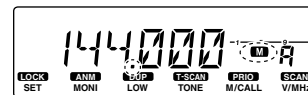

“.” and “M” blink.

## 4. SCAN OPERATION

### Memory Bank scan

#### ◇ Bank Link scan

A Bank Link scan searches the linked banks.

**NOTE:** To use a Bank Link scan,

- The Bank Link function must be turned ON and two or more Banks are linked in the Set mode. (p. 8-4)
- Two or more Memory channels, which are not set as Skip channels, must be entered into the linked banks.

1. Repeatedly push [M/CALL PRIO] to select the Memory mode.
  - “M” and the Memory Channel number are displayed.
2. Push [BANK OPT] to select the Memory Bank mode.
  - “M” and the bank letter blink.
  - ① The bank name is displayed, if set.
3. Rotate [DIAL] to select any bank.
  - ① Banks that contain no Memory channels are skipped.
4. Push any key to exit the Memory Bank mode.
  - “M” and the bank letter are displayed.
5. Hold down [V/MHz SCAN] for 1 second to start scanning.
  - The frequency decimal point and “M” blink.
  - ① When a signal is detected, the scan pauses according to the Scan Stop timer setting, and then resumes.
  - ① Push [MONI ANM PA] to stop or resume the scan.
6. Push [V/MHz SCAN] to cancel the scan.

**TIP:** During a scan, rotating [DIAL] changes the scanning direction.

#### Example: Starting a Bank Link scan.

Repeatedly push [M/CALL PRIO] to select the Memory mode.

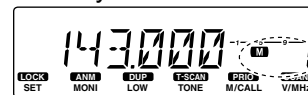

“M” and the Memory Channel number are displayed.

Push [BANK OPT] to enter the Memory Bank mode.

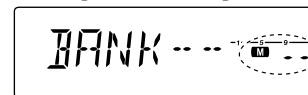

“M” and the bank letter blink.

Rotate [DIAL] to select any bank. (Example: Bank A)



Push any key to exit the Memory Bank mode.

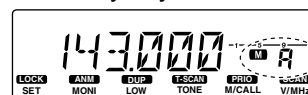

“M” and the bank letter are displayed.

Hold down [V/MHz SCAN] for 1 second to start scanning.

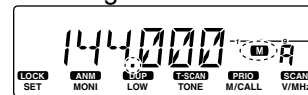

“.” and “M” blink.

## 4. SCAN OPERATION

### Memory Bank scan

#### Using the HM-133V MICROPHONE

1. Push [MR/CALL] to select the Memory mode.
  - “M” and the Memory Channel number are displayed.
2. Push [BANK/OPTION] to select the Memory Bank mode.
  - “M” and the bank letter blink.
  - ① The bank name is displayed, if set.
3. Push [▲] or [▼] to select any bank.
  - ① Banks that contain no Memory channels are skipped.
4. Push [CLR A MW] to exit the Memory Bank mode.
  - “M” and the bank letter are displayed.
5. Push [SCAN 2 T-SCAN] to start scanning.
  - The frequency decimal point and “M” blink.
  - ① When a signal is detected, the scan pauses according to the Scan Stop timer setting, and then resumes.
  - ① Push [MONI 1 ANM] to stop or resume the scan.
6. Push [SCAN 2 T-SCAN] to cancel the scan.

**TIP:** You can also start scanning by holding down [▲] or [▼] for 1 second.

#### Example: Starting a Bank scan in Bank A.

Push  to select the Memory mode.

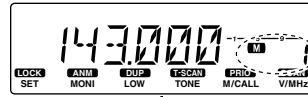



“M” and the Memory Channel number are displayed.

Push  to enter the Memory Bank mode.



“M” and the bank letter blink.

Push  or  to select any bank. (Example: Bank A)



Push  to exit the Memory Bank mode.

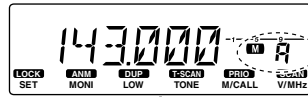

“M” and the bank letter are displayed.

Push  to start scanning.

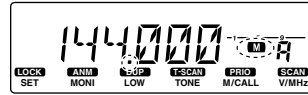

“.” and “M” blink.

## 4. SCAN OPERATION

### Entering Scan Edges

You can enter the upper and lower frequency edges for a Programmed scan. Each Program Scan range has its own tuning steps. You can enter a total of up to 3 Program Scan ranges.

1. Set the frequency in the VFO mode.
2. Push [S.MW MW].
  - “M” and the Memory Channel number blink.
3. Rotate [DIAL] to select the Scan Edge channel.
  - ① 1A/1B, 2A/2B, or 3A/3B can be selected.
  - 1B, 2B, and 3B are displayed as “1b,” “2b,” and “3b.”
4. Hold down [S.MW MW] for 1 second to write.
  - Three beeps sound, and then returns to the VFO mode.
  - ① The Scan Edge Channel number automatically increases when holding down [S.MW MW] after writing.

#### Example: Entering 145.300 MHz to Scan Edge 1A.

Set the frequency.

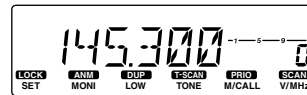

Push [S.MW MW].

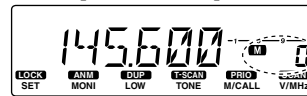

“M” and the Memory Channel number blink.

Rotate [DIAL] to select the Scan Edge channel.

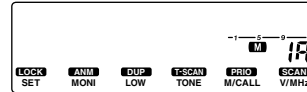

Hold down [S.MW MW] for 1 second to write.

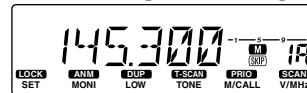

3 beeps sound.

#### Using the HM-133V MICROPHONE

1. Set the frequency in the VFO mode.
2. Push [FUNC], and then [CLR A MW].
  - “M” and the Memory Channel number blink.
3. Push [▲] or [▼] to select the Scan Edge channel.
4. Push [FUNC], and then hold down [CLR A MW] for 1 second to write.
  - Three beeps sound, and then returns to the VFO mode.
  - ① The Scan Edge Channel number automatically increases when holding down [CLR A MW] after writing.

#### Example: Entering 145.300 MHz to Scan Edge 1A.

Set the frequency.



Push [FUNC], and then [MW CLR A].

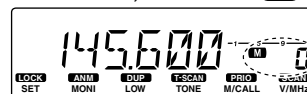

“M” and the Memory Channel number blink.

Push [▲] or [▼] to select the Scan Edge channel.

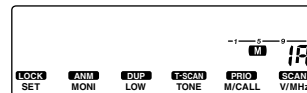

Push [FUNC], and then hold down [MW CLR A] for 1 second.

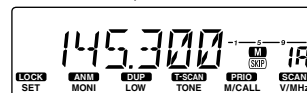

3 beeps sound.

## 4. SCAN OPERATION

### Setting a Skip channel

You can set or clear a Skip channel. The Memory channels set as a Skip channel are skipped during a scan.

1. Repeatedly push [M/CALL PRIO] to select the Memory mode and rotate [DIAL] to select a Memory channel.
2. Push [SET LOCK] to enter the Set mode.
  - ① You cannot enter the Set mode when the Channel Name Display mode is selected. To exit this mode, hold down [MONI ANM PA] for 1 second, and then do step 2. See page 3-8 for details.
  - ② When "NM" is selected in "DSP" (Display type) in the Initial Set mode, you can enter the Set mode, even if the channel name is displayed. (p. 8-6)
3. Repeatedly push [SET LOCK] or [MONI ANM PA] to select "CHS" (Channel skip setting).
4. Rotate [DIAL] to select "ON."
  - "SKIP" is displayed.
  - ① To clear a Skip channel, select "OF."
5. Push any key other than [SET LOCK] or [MONI ANM PA] to save and exit the Set mode.

#### Example: Setting Memory channel 20 as a Skip channel.

Select Memory channel 20.

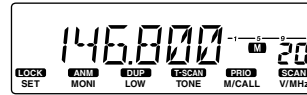

Push [SET LOCK] to enter the Set mode.

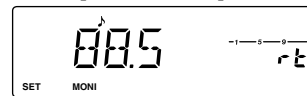

Push [SET LOCK] or [MONI ANM] to select "CHS."

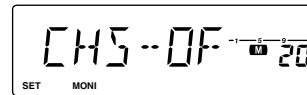

Rotate [DIAL] to select "ON."

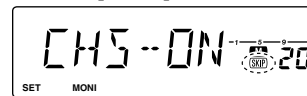

"SKIP" is displayed.

#### Using the HM-133V MICROPHONE

1. Push [MR/CALL] to select the Memory mode and push [▲] or [▼] to select a Memory channel.
2. Push [SET B D-OFF] to enter the Set mode.
  - ① You cannot enter the Set mode when the Channel Name Display mode is selected. To exit this mode, push [FUNC], and then [MONI 1 ANM], and then do step 2. See page 3-8 for details.
  - ② When "NM" is selected in "DSP" (Display type) in the Initial Set mode, you can enter the Set mode, even if the channel name is displayed. (p. 8-6)
3. Push [SET B D-OFF] or [ENT C T-OFF] to select "CHS" (Channel skip setting).
4. Push [▲] to select "ON."
  - "SKIP" is displayed.
  - ① To clear a Skip channel, push [▼] to select "OF."
5. Push [CLR A MW] to save and exit the Set mode.

#### Example: Setting Memory channel 20 as a Skip channel.

Select Memory channel 20.

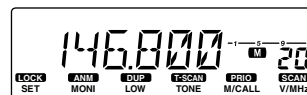

Push [D-OFF SET B] to enter the Set mode.

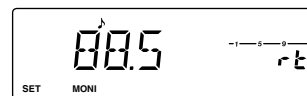

Push [D-OFF SET B] or [T-OFF ENT C] to select "CHS."

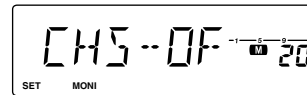

Push [▲] to select "ON."

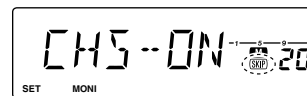

"SKIP" is displayed.

## Section 5

## PRIORITY WATCH

---

About the Priority watch.....	5-2
VFO frequency and a Memory/Call channel.....	5-3
VFO frequency and a Memory scan.....	5-4
VFO frequency and a Memory Bank scan.....	5-5
◇ Bank scan.....	5-5
◇ Bank Link scan .....	5-7

## 5. PRIORITY WATCH

### About the Priority watch

While operating on a VFO frequency, the Priority watch searches for signals on a selected frequency every 5 seconds. There are 5 ways to use the Priority watch.

**Watching a Memory or Call channel while receiving in the VFO mode.** (p. 5-3)

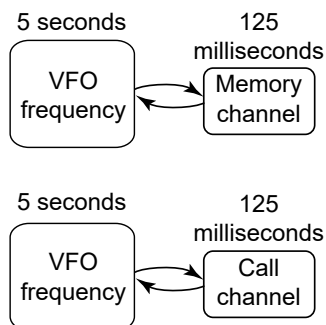

**Scanning while receiving in the VFO mode.** (pp. 5-4, 5-5, 5-7)

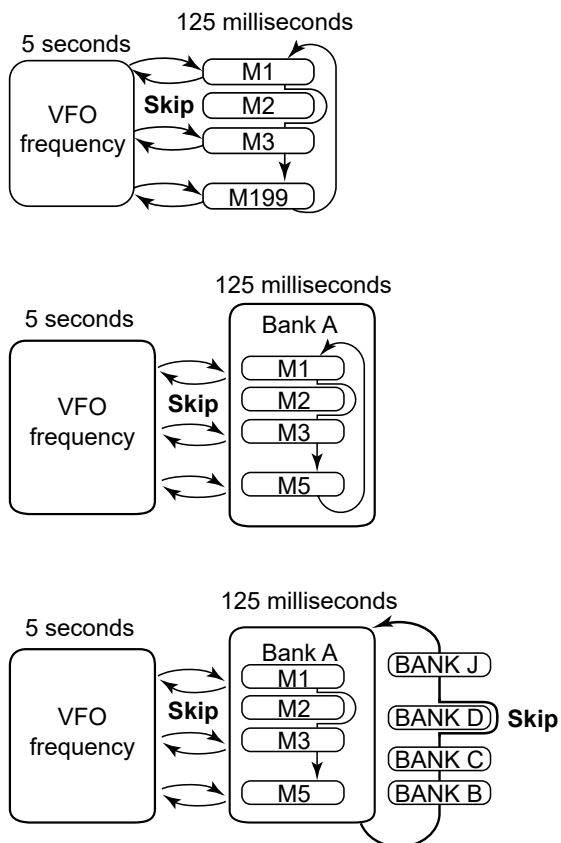

## 5. PRIORITY WATCH

# VFO frequency and a Memory/Call channel

Searches the selected Memory or Call channel every 5 seconds while receiving on a VFO frequency.

1. Set the receive frequency.
2. Set the Priority channel.
  - To select a Memory channel**  
Repeatedly push [M/CALL PRIO] to select the Memory mode, and then rotate [DIAL] to select the Memory channel.
  - To select a Call channel**  
Repeatedly push [M/CALL PRIO] to select the Call channel.
3. Hold down [M/CALL PRIO] for 1 second to start the Priority watch.
  - "PRIO" is displayed.
4. Push [M/CALL PRIO] to cancel the watch.
  - "PRIO" disappears.

**TIP: When a signal is received**

- "PRIO" blinks.
- The Memory or Call channel is automatically selected.

① The Scan Pause timer and Scan Resume timer settings are the same as those for a normal scan. (p. 8-3)

"PRIO" blinks.

### Using the HM-133V MICROPHONE

1. Set the receive frequency.
2. Set the Priority channel.
  - To select a Memory channel**  
Repeatedly push [MR/CALL] to select the Memory mode, and then push [▲] or [▼] to select the Memory channel.
  - To select a Call channel**  
Hold down [MR/CALL] for 1 second to select the Call channel.
3. Push [PRIO 3 PTT-M] to start the Priority watch.
  - "PRIO" is displayed.
4. Push [PRIO 3 PTT-M] to cancel the watch.
  - "PRIO" disappears.

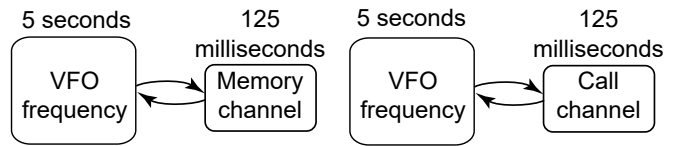

### Example: Watching Memory channel 20 while receiving in the VFO mode.

Set the receive frequency.

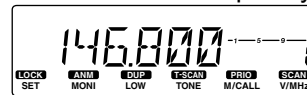

Repeatedly push [M/CALL PRIO] to select the Memory mode.

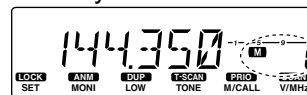

"M" and the Memory Channel number are displayed.

Rotate [DIAL] to select Memory channel 20.

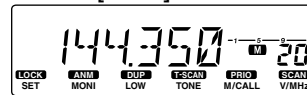

Hold down [M/CALL PRIO] for 1 second to start the Priority watch.

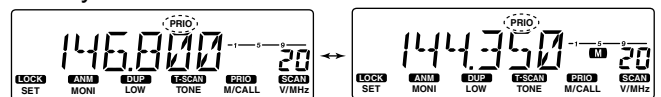

"PRIO" is displayed.

The Priority watch searches for a signal on Memory channel 20 every 5 seconds.

Set the receive frequency.

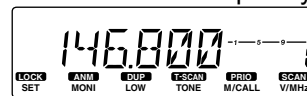

Push [MR/CALL] to select the Memory mode.

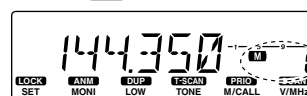

"M" and the Memory Channel number are displayed.

Push [▲] or [▼] to select Memory channel 20.

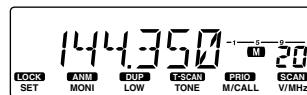

Push [PTT-M PRIO 3] to start the Priority watch.

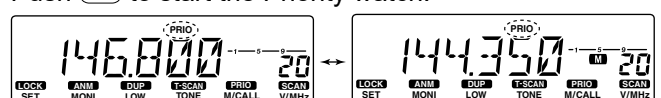

"PRIO" is displayed.

The Priority watch searches a signal on Memory channel 20 every 5 seconds.

5. PRIORITY WATCH

## VFO frequency and a Memory scan

Searches the scanned Memory channels every 5 seconds while receiving on a VFO frequency.

1. Set the receive frequency.
2. Repeatedly push [M/CALL PRIO] to select the Memory mode.
  - “M” and the Memory Channel number are displayed.
3. Hold down [V/MHz SCAN] for 1 second to start scanning.
  - The frequency decimal point and “M” blink.
4. Hold down [M/CALL PRIO] for 1 second to start the Priority watch.
  - “PRIO” is displayed.
5. Push [M/CALL PRIO] to cancel the watch.
  - “PRIO” disappears.

**TIP: When a signal is received**

- “PRIO” blinks.
- The Memory channel is automatically selected.
- ① The Scan Pause timer and Scan Resume timer settings are the same as those for a normal scan. (p. 8-3)

“PRIO” blinks.

### Using the HM-133V MICROPHONE

1. Set the receive frequency in the VFO mode.
2. Repeatedly push [MR/CALL] to select the Memory mode.
  - “M” and the Memory Channel number are displayed.
3. Push [SCAN 2 T-SCAN] to start scanning.
  - The frequency decimal point and “M” blink.
4. Push [PRIO 3 PTT-M] to start the Priority watch.
  - “PRIO” is displayed.
5. Push [PRIO 3 PTT-M] to cancel the watch.
  - “PRIO” disappears.

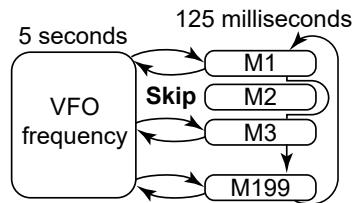

**Example: Watching a Full Memory scan while receiving in the VFO mode.**

Set the receive frequency.

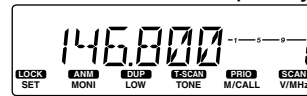

Repeatedly push [M/CALL PRIO] to select the Memory mode.



Push [V/MHz SCAN] to start a Full Memory scan.

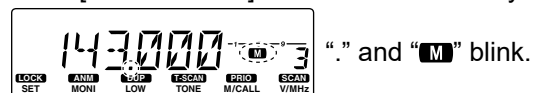

Hold down [M/CALL PRIO] for 1 second to start the Priority watch.

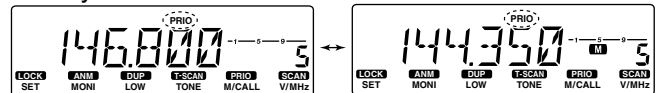

“PRIO” is displayed.

The Priority watch searches for a signal on the scanned Memory channels every 5 seconds.

Set the receive frequency.

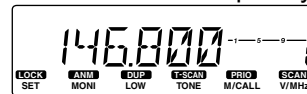

Push [MR/CALL] to select the Memory mode.



Push [SCAN 2 T-SCAN] to start a Full Memory scan.

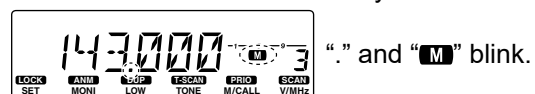

Push [PTT-M PRIO 3] to start the Priority watch.

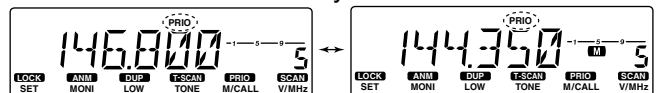

“PRIO” is displayed.

The Priority watch searches for a signal on the scanned Memory channels every 5 seconds.

5. PRIORITY WATCH

# VFO frequency and a Memory Bank scan

## ◇ Bank scan

Searches the Memory channels in the selected bank every 5 seconds while receiving on a VFO frequency.

1. Set the receive frequency.
2. Repeatedly push [M/CALL PRIO] to select the Memory mode.
  - “M” and the Memory Channel number are displayed.
3. Push [BANK OPT] to select the Memory Bank mode.
  - “M” and the bank letter blink.
  - ① The bank name is displayed, if set.
4. Rotate [DIAL] to select the desired bank.
5. Push any key to exit the Memory Bank mode.
  - “M” and the bank letter are displayed.
6. Hold down [V/MHz SCAN] for 1 second to start scanning.
  - The frequency decimal point and “M” blink.
7. Hold down [M/CALL PRIO] for 1 second to start the Priority watch.
  - “PRIO” is displayed.
8. Push [M/CALL PRIO] to cancel the watch.
  - “PRIO” disappears.

**TIP: When a signal is received**

- “PRIO” blinks.
- The Memory channel is automatically selected.
- ① The Scan Pause timer and Scan Resume timer settings are the same as those for a normal scan. (p. 8-3)

“PRIO” blinks.

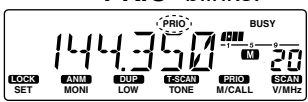

Example: BANK A (M1 to M5 are included)

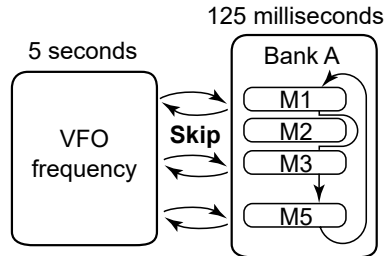

Example: Watching a Bank scan while receiving in the VFO mode.

Set the receive frequency.

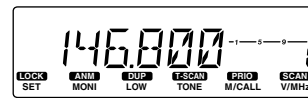

Repeatedly push [M/CALL PRIO] to select the Memory mode.

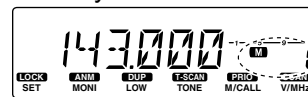

“M” and the Memory Channel number are displayed.

Push [BANK OPT] to enter the Memory Bank mode.



Rotate [DIAL] to select the bank. (Example: Bank A)



Push any key to exit the Memory Bank mode.

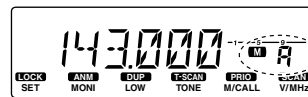

“M” and the bank letter are displayed.

Hold down [V/MHz SCAN] for 1 second to start scanning.

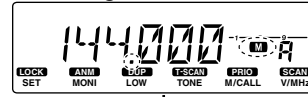

“.” and “M” blink.

Hold down [M/CALL PRIO] for 1 second to start the Priority watch.

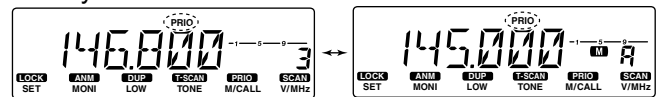

“PRIO” is displayed.

The Priority watch searches for a signal on the Memory channels in the selected bank every 5 seconds.

## 5. PRIORITY WATCH

### VFO frequency and a Memory Bank scan

#### Using the HM-133V MICROPHONE

1. Set the receive frequency.
2. Push [MR/CALL] to select the Memory mode.
  - “M” and the Memory Channel number are displayed.
3. Push [BANK/OPTION] to select the Memory Bank mode.
  - “M” and the bank letter blink.
  - ① The bank name is displayed, if set.
4. Push [▲] or [▼] to select the desired bank.
  - ① Banks that contain no Memory channels are skipped.
5. Push [CLR A MW] to exit the Memory Bank mode.
  - “M” and the bank letter are displayed.
6. Push [SCAN 2 T-SCAN] to start scanning.
  - The frequency decimal point and “M” blink.
7. Push [PRIO 3 PTT-M] to start the Priority watch.
  - “PRIO” is displayed.
8. Push [PRIO 3 PTT-M] to cancel the watch.
  - “PRIO” disappears.

#### Example: Watching a Bank scan while receiving in the VFO mode.

Set the receive frequency.

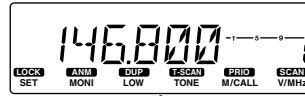

Push [MR/CALL] to select the Memory mode.

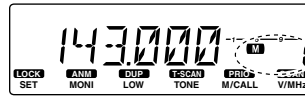

“M” and the Memory Channel number are displayed.

Push [BANK/OPTION] to enter the Memory Bank mode.



Push [▲] or [▼] to select the bank. (Example: Bank A)



Push [MW CLR A] to exit the Memory Bank mode.

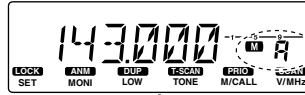

“M” and the bank letter are displayed.

Push [T-SCAN SCAN2] to start scanning.

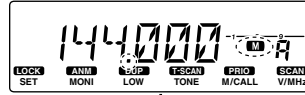

“.” and “M” blink.

Push [PTT-M PRIO 3] to start the Priority watch.

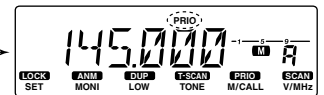
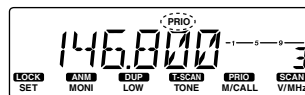

“PRIO” is displayed.

The Priority watch searches for a signal on the scanned Memory channels in the selected bank every 5 seconds.

## 5. PRIORITY WATCH

### VFO frequency and a Memory Bank scan

#### ◇ Bank Link scan

Searches the Memory channels in the linked banks every 5 seconds while receiving on a VFO frequency.

**NOTE:** To use a Bank Link scan, the Bank Link function must be turned ON and two or more Banks are linked in the Set mode. (p. 8-4)

1. Set the receive frequency.
2. Repeatedly push [M/CALL PRIO] to select the Memory mode.
  - “M” and the Memory Channel number are displayed.
3. Push [BANK OPT] to select the Memory Bank mode.
  - “M” and the bank letter blink.
  - ① The bank name is displayed, if set.
4. Rotate [DIAL] to select any bank.
5. Push any key to exit the Memory Bank mode.
  - “M” and the bank letter are displayed.
6. Hold down [V/MHz SCAN] for 1 second to start scanning.
  - The frequency decimal point and “M” blink.
7. Hold down [M/CALL PRIO] for 1 second to start the Priority watch.
  - “PRIO” is displayed.
8. Push [M/CALL PRIO] to cancel the watch.
  - “PRIO” disappears.

#### TIP: When a signal is received

- “PRIO” blinks.
- The Memory channel is automatically selected.
- ① The Scan Pause timer and Scan Resume timer settings are the same as those for a normal scan. (p. 8-3)

“PRIO” blinks.

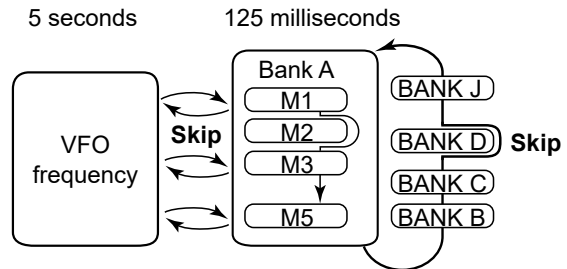
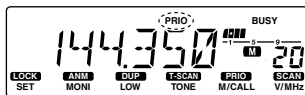

#### Example: Watching a Bank Link scan while receiving in the VFO mode.

Set the receive frequency.

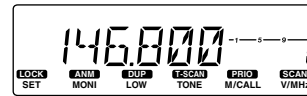

Repeatedly push [M/CALL PRIO] to select the Memory mode.

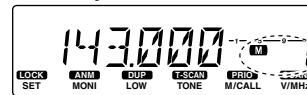

“M” and the Memory Channel number are displayed.

Push [BANK OPT] to enter the Memory Bank mode.



Rotate [DIAL] to select any bank. (Example: Bank A)

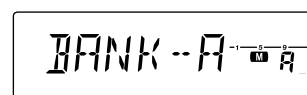

Push any key to exit the Memory Bank mode.

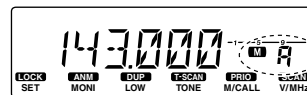

“M” and the bank letter are displayed.

Hold down [V/MHz SCAN] for 1 second to start scanning.

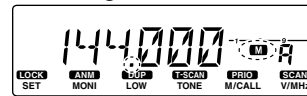

“.” and “M” blink.

Hold down [M/CALL PRIO] for 1 second to start the Priority watch.

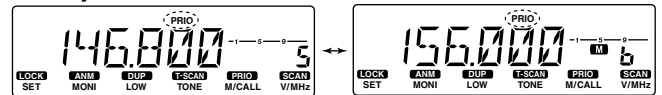

“PRIO” is displayed.

The Priority watch searches for a signal on the Memory channels in the linked banks every 5 seconds.

## 5. PRIORITY WATCH

### VFO frequency and a Memory Bank scan

#### Using the HM-133V MICROPHONE

1. Set the receive frequency.
2. Push [MR/CALL] to select the Memory mode.
  - “M” and the Memory Channel number are displayed.
3. Push [BANK/OPTION] to select the Memory Bank mode.
  - “M” and the bank letter blink.
  - ① The bank name is displayed, if set.
4. Push [▲] or [▼] to select any bank.
  - ① Banks that contain no Memory channels are skipped.
5. Push [CLR A MW] to exit the Memory Bank mode.
  - “M” and the bank letter are displayed.
6. Push [SCAN 2 T-SCAN] to start scanning.
  - The frequency decimal point and “M” blink.
7. Push [PRIO 3 PTT-M] to start the Priority watch.
  - “PRIO” is displayed.
8. Push [PRIO 3 PTT-M] to cancel the watch.
  - “PRIO” disappears.

#### Example: Watching a Bank scan while receiving in the VFO mode.

Set the receive frequency.

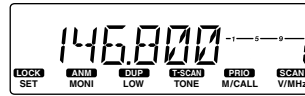

Push [MR/CALL] to select the Memory mode.

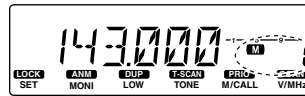

“M” and the Memory Channel number are displayed.

Push [BANK/OPTION] to enter the Memory Bank mode.



Push [▲] or [▼] to select any bank. (Example: Bank A)



Push [MW CLR A] to exit the Memory Bank mode.

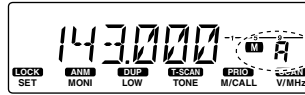

“M” and the bank letter are displayed.

Push [SCAN 2 T-SCAN] to start scanning.

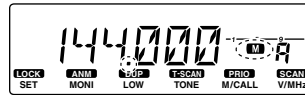

“.” and “M” blink.

Push [PTT-M PRIO 3] to start the Priority watch.

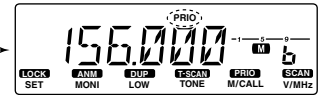
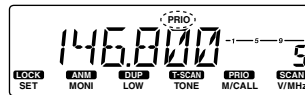

“PRIO” is displayed.

The Priority watch searches for a signal on the scanned Memory channels in the selected bank every 5 seconds.

## Section 6 DTMF MEMORY

---

Entering a DTMF code .....	6-2
Transmitting a DTMF code .....	6-4
◇ Automatic DTMF Memory transmission .....	6-4
◇ Manual DTMF Memory transmission (Using the HM-133V MICROPHONE).....	6-5
◇ Manual DTMF code transmission (Using the HM-133V MICROPHONE).....	6-5
Selecting the DTMF transmit speed .....	6-6

6. DTMF MEMORY

## Entering a DTMF code

DTMF codes are used for auto-patching, controlling other equipment, and so on. The transceiver has up to 16 DTMF Memory channels (d0–dF) for up to 24 digit often-used DTMF codes.

**NOTE:** To enter a DTMF code, “BAK” or “TVo” must be selected in the “OK” ([BANK/OPT] key) in the Initial Set mode. (p. 8-6)

1. Hold down [BANK OPT] for 1 second to enter the Option Set mode.
2. Push [SET LOCK] or [MONI ANM PA] to select “DTM.”
3. Rotate [DIAL] to select “ON.”
  - The DTMF Memory encoder is turned ON.
4. Push [BANK OPT] to enter the DTMF Memory mode.
  - The DTMF Memory Channel number blinks.
  - ① The previously entered DTMF code is displayed, if set.

**NOTE:** The previously entered code in the selected DTMF Memory channel will be cleared by doing the following steps.

5. Rotate [DIAL] to select the desired blank DTMF Memory channel.
6. Push [SET LOCK] or [MONI ANM PA] to enter the DTMF Memory Programming mode.
  - The first digit (--) blinks.
7. Rotate [DIAL] to select the character.
8. Push [MONI ANM PA] to set the character.
  - After the character is set, the next digit is automatically selected.
  - ① Push [SET LOCK] to go back to the previous digit.
  - ① When the 6th character is set, the next 6 blank digit group will be displayed.
  - ① The S/R/F indicator shows the number of digits being displayed, as shown below.

Indicator	The number of digits being displayed
	19 ~ 24
	13 ~ 18
	7 ~ 12
	1 ~ 6

9. Repeat steps 7 and 8 until the desired DTMF code entry (up to 24 digits) is completed.
10. Push any key other than [SET LOCK] or [MONI ANM PA] to set the code and exit the DTMF Memory Programming mode.
  - The 100 MHz digit is changed to “d.”
  - ① To go back to the Option Set mode, hold down [BANK OPT] for 1 second.

### Example: Entering “5428AB453” into DTMF Memory channel “d3.”

Hold down [BANK OPT] for 1 second to enter the Option Set mode.

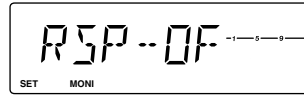

Push [SET LOCK] or [MONI ANM PA] to select “DTM.”

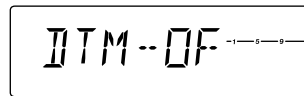

Rotate [DIAL] to select “ON.”

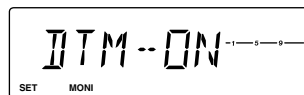

Push [BANK OPT] to enter the DTMF Memory mode.

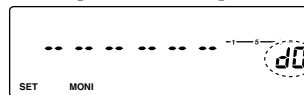

The DTMF Memory Channel number blinks.

Rotate [DIAL] to select “d3.”

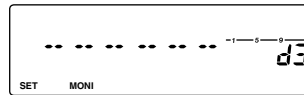

Push [SET LOCK] to enter the DTMF Memory Programming mode.

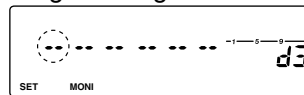

The first digit blinks.

Rotate [DIAL] to select the character.

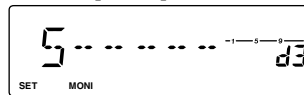

Push [MONI ANM PA] to set the character.

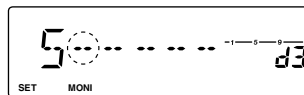

The next digit blinks.

Repeat until the desired DTMF code entry is complete.

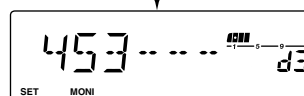

Push any key other than [SET LOCK] or [MONI ANM PA] to set the code and exit the DTMF Memory Programming mode.



The 100 MHz digit is changed to “d.”

## 6. DTMF MEMORY

### Entering a DTMF code

#### Using the HM-133V MICROPHONE

1. Hold down [BANK/OPTION] for 1 second to enter the Option Set mode.
2. Push [MR/CALL] to select "DTM" (DTMF Memory channel).
3. Push [▲] to select "ON."
  - The DTMF Memory encoder is turned ON.
4. Push [SET B D-OFF] to enter the DTMF Memory mode.
  - The DTMF Memory Channel number blinks.
  - ① The previously entered DTMF code is displayed, if set.

**NOTE:** The previously entered code in the selected DTMF Memory channel will be cleared by doing the following steps.

5. Push [▲] or [▼] to select the desired blank DTMF Memory channel.
6. Push a keypad key to set the desired DTMF code.
  - The transceiver automatically enters the DTMF Memory Programming mode.
  - ① The [0] to [9], [A] to [D], [\*] (E), and [#] (F) keys can be used.

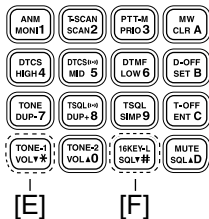

7. Repeat step 6 until the desired DTMF code entry (up to 24 digits) is completed.
8. Push [▲] or [▼] to set the code.
9. Push [VFO/LOCK] to exit the DTMF Memory Programming mode.
  - The 100 MHz digit is changed to "d."
  - ① To go back to the Option Set mode, push [BANK/OPTION].

#### Example: Entering "5428AB453" into DTMF Memory channel "d3."

Hold down [BANK/OPTION] for 1 second to enter the Option Set mode.

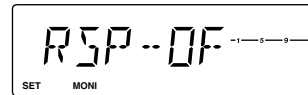

Push [MR/CALL] to select "DTM."

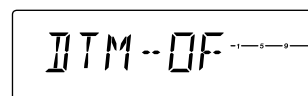

Push [▲] to select "ON."

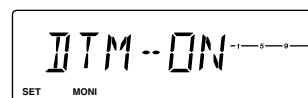

Push [D-OFF SET B] enter the DTMF Memory mode.

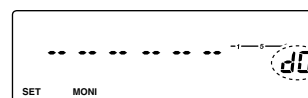

The DTMF Memory Channel number blinks.

Push [▲] or [▼] to select "d3."

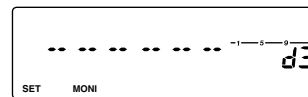

Push [DTCS MID 5] to enter "5."



Repeatedly push keypad keys until the desired DTMF code entry is complete.

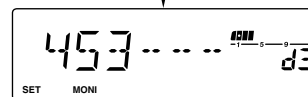

Push [▲] or [▼] to set the code.

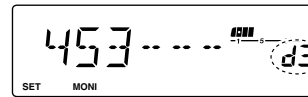

The DTMF Memory Channel number stops blinking.

Push [VFO/LOCK] to exit the DTMF Memory Programming mode.

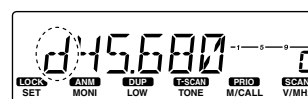

The 100 MHz digit is changed to "d."

6. DTMF MEMORY

## Transmitting a DTMF code

The transceiver has 3 methods of transmitting a DTMF code.

### ◇ Automatic DTMF Memory transmission

1. Hold down [BANK OPT] for 1 second to select the Option Set mode.
2. Push [SET LOCK] or [MONI ANM PA] to select "DTM" (DTMF Memory channel).
3. Rotate [DIAL] to select "ON."
  - The DTMF Memory encoder is turned ON.
4. Push [BANK OPT] to enter the DTMF Memory mode.
  - The selected DTMF Memory channel blinks.
  - ① The previously entered DTMF code is displayed, if set.
5. Rotate [DIAL] to select the DTMF Memory channel.
6. Push any key other than [SET LOCK] or [MONI ANM PA] to exit the desired DTMF Memory mode.
  - The 100 MHz digit is changed to "d."
7. Push [PTT].
  - The selected DTMF code is transmitted.
  - ① To turn OFF the DTMF Memory encoder, select "OF" in "DTM" in the Option Set mode.

#### Example: Transmitting the DTMF code in the DTMF Memory channel "d3."

Hold down [BANK OPT] for 1 second to enter the Option Set mode.

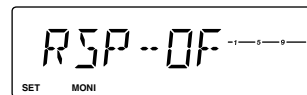

Push [SET LOCK] or [MONI ANM PA] to select "DTM."



Rotate [DIAL] to select "ON."

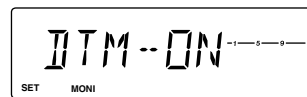

Push [BANK OPT] to enter the DTMF Memory mode.

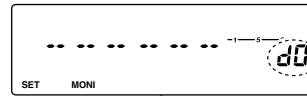

The DTMF Memory Channel number blinks.

Rotate [DIAL] to select "d3."

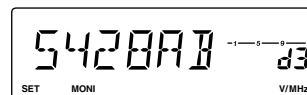

Push any key other than [SET LOCK] or [MONI ANM PA] to exit the DTMF Memory mode.

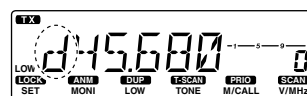

The 100 MHz digit is changed to "d."

Push [PTT].

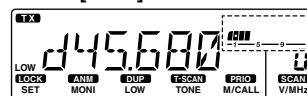

The selected DTMF code is transmitted.

The S/R/F indicator displays the output power level.

## 6. DTMF MEMORY

### Transmitting a DTMF code

#### ◇ Manual DTMF Memory transmission (Using the HM-133V MICROPHONE)

1. Push [FUNC], and then [LOW 6 DTMF] to turn ON the DTMF Memory encoder.
  - The 100 MHz digit on the function display is changed to "d."
2. Push [DTMF-S] to turn ON the DTMF direct selection.
  - The function indicator lights green.
3. Push a keypad key to select the desired DTMF Memory Channel number.
  - The selected DTMF code is automatically transmitted.
  - The activity indicator lights red.
4. Push [DTMF-S] to turn OFF the DTMF direct selection.
  - The function indicator disappears.
5. Push [FUNC], and then [SET B D-OFF] to turn OFF the DTMF Memory encoder.

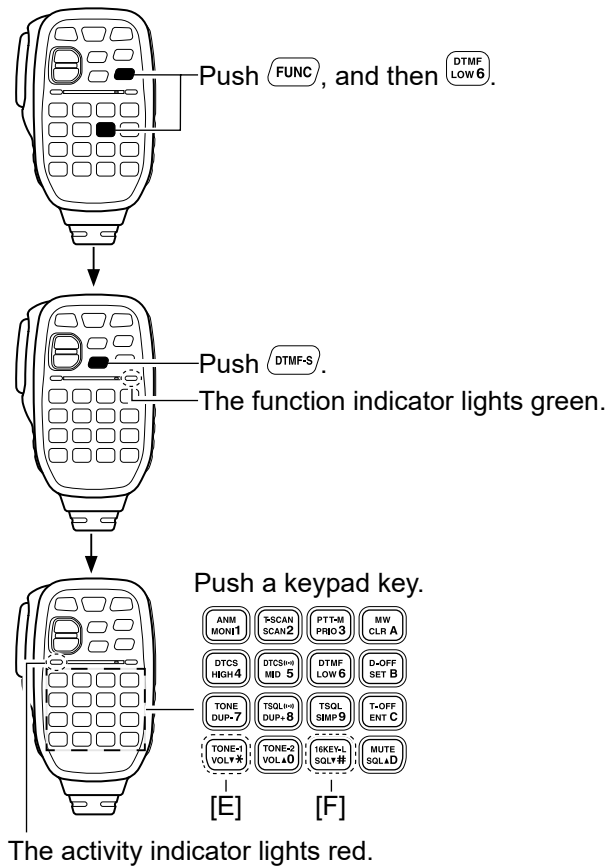

#### ◇ Manual DTMF code transmission (Using the HM-133V MICROPHONE)

1. Push [FUNC], and then [SET B D-OFF] to turn OFF the DTMF Memory encoder.
2. Push [DTMF-S] to turn ON the DTMF direct selection.
  - The function indicator lights green.
3. Push a keypad key to transmit the desired DTMF code.
  - The activity indicator lights red.
  - ① The first entered code may not be transmitted because transmitting takes 400 milliseconds. The transceiver starts a DTMF code transmission from the second code.
4. Push [DTMF-S] to turn OFF the DTMF direct selection.
  - The function indicator disappears.

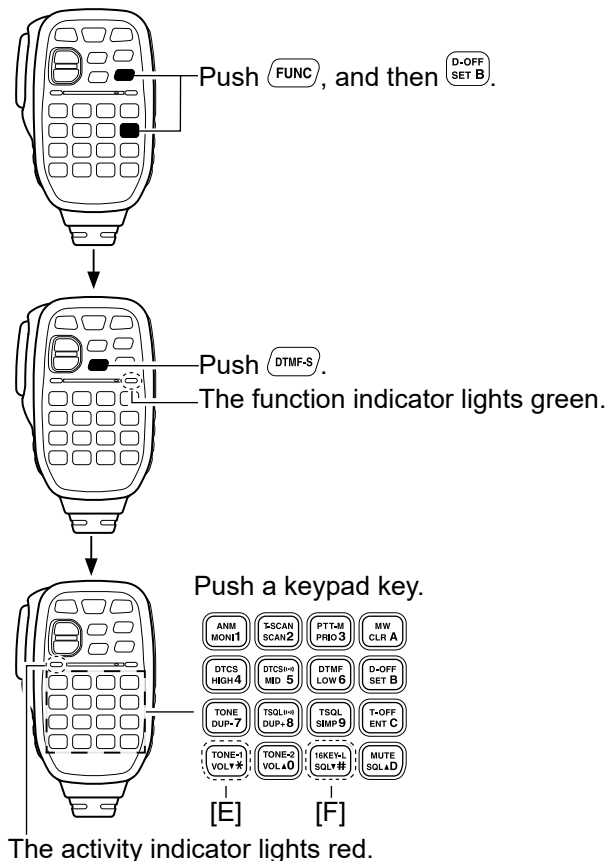

## 6. DTMF MEMORY

### Selecting the DTMF transmit speed

The transmit speed of the DTMF code can be set to accommodate your operating needs.

1. While holding down [SET LOCK], hold down [⏻] for 1 second to enter the Initial Set mode.
2. Repeatedly push [SET LOCK] or [MONI ANM PA] to select "DTD" (DTMF speed).
3. Rotate [DIAL] to select the desired transmit speed, as shown below.

Display	Interval	Speed
DTD-1	100 milliseconds	5.0 cps
DTD-2	200 milliseconds	2.5 cps
DTD-3	300 milliseconds	1.6 cps
DTD-5	500 milliseconds	1.0 cps

cps=characters/second

4. Push [⏻] to save and exit the Initial Set mode.

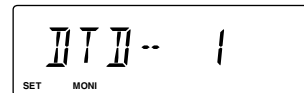

The DTMF speed item

## Section 7

## TONE SQUELCH AND POCKET BEEP

---

Tone/DTCS squelch.....	7-2
◇ Tone squelch and DTCS squelch .....	7-2
◇ Reverse Tone/DTCS squelch .....	7-2
◇ Setting CTCSS tone or DTCS code .....	7-2
◇ Setting DTCS polarity.....	7-2
◇ Operation.....	7-3
Pocket Beep function.....	7-5
◇ Waiting for a call from a specific station .....	7-5
◇ Calling a waiting station using the Pocket Beep function .....	7-6
Tone scan .....	7-7
DTCS encoder (Transmit only).....	7-8

## Tone/DTCS squelch

### ◇ Tone squelch and DTCS squelch

The CTCSS Tone squelch or DTCS squelch opens when a signal with a matched tone or code is received.

### ◇ Reverse Tone/DTCS squelch

The Reverse Tone/DTCS squelch convenient when you want to ignore a specific signal. The transceiver mutes the squelch when a signal with a matched tone or code is received.

### ◇ Setting CTCSS tone or DTCS code

1. Set the operating frequency.
2. Push [SET LOCK] to enter the Set mode.
3. Repeatedly push [SET LOCK] or [MONI ANM PA] to select “ $\nabla$ ” and “Ct” (Tone Squelch frequency) or “ $\text{\textcircled{D}}$ ” and “dt” (DTCS code).
4. Rotate [DIAL] to select the desired tone or code.
5. Push any key other than [SET LOCK] or [MONI ANM PA] to save and exit the Set mode.

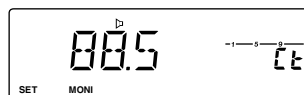

The Tone Squelch frequency item

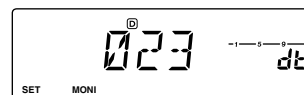

The DTCS code item

#### Selectable Tone Squelch frequencies (unit: Hz)

67.0	79.7	94.8	110.9	131.8	156.7	171.3	186.2	203.5	229.1
69.3	82.5	97.4	114.8	136.5	159.8	173.8	189.9	206.5	233.6
71.9	85.4	100.0	118.8	141.3	162.2	177.3	192.8	210.7	241.8
74.4	88.5	103.5	123.0	146.2	165.5	179.9	196.6	218.1	250.3
77.0	91.5	107.2	127.3	151.4	167.9	183.5	199.5	225.7	254.1

#### Selectable DTCS codes

023	065	132	205	255	331	413	465	612	731
025	071	134	212	261	332	423	466	624	732
026	072	143	223	263	343	431	503	627	734
031	073	145	225	265	346	432	506	631	743
032	074	152	226	266	351	445	516	632	754
036	114	155	243	271	356	446	523	654	
043	115	156	244	274	364	452	526	662	
047	116	162	245	306	365	454	532	664	
051	122	165	246	311	371	455	546	703	
053	125	172	251	315	411	462	565	712	
054	131	174	252	325	412	464	606	723	

### ◇ Setting DTCS polarity

1. Set the operating frequency.
2. Push [SET LOCK] to enter the Set mode.
3. Repeatedly push [SET LOCK] or [MONI ANM PA] to select “DTP” (DTCS polarity).
4. Rotate [DIAL] to select the desired DTCS Polarity mode.
  - NN: Normal polarity is used for both TX and RX.
  - NR: Normal polarity is used for TX, Reverse polarity for RX.
  - RN: Reverse polarity is used for TX, Normal polarity for RX.
  - RR: Reverse polarity is used for both TX and RX.
5. Push any key other than [SET LOCK] or [MONI ANM PA] to save and exit the Set mode.

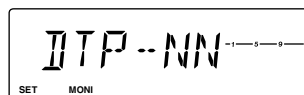

The DTCS polarity item

## 7. TONE SQUELCH AND POCKET BEEP

### Tone/DTCS squelch

#### ◇ Operation

1. Set the operating frequency.
2. Push [SET LOCK] to enter the Set mode.
3. Set the Tone Squelch frequency or DTCS code and DTCS polarity.
  - ① See the previous page for details.
4. Push any key other than [SET LOCK] or [MONI ANM PA] to save and exit the Set mode.
5. Repeatedly push [TONE T-SCAN] to select the desired tone or code.
  - “**▷**” : Tone squelch
  - “**Ⓞ**” : DTCS squelch
  - “**▷**” and “**-R**” : Reverse Tone squelch
  - “**Ⓞ**” and “**-R**” : Reverse DTCS squelch
6. Operate normally.
  - ① To manually open the squelch, push [MONI ANM PA].

**When the Tone or DTCS squelch is selected:**  
When a signal with a matching tone or code is received, the squelch opens, and audio is heard.

  - ① If a signal with an unmatching tone is received, the squelch does not open. However, the S/RF indicator shows the strength of the received signal.

**When the Reverse Tone or DTCS squelch is selected:**  
When a signal with a matching tone or code is received, the squelch remains closed.
7. To cancel the Tone or DTCS squelch, repeatedly push [TONE T-SCAN] until the tone icon disappears.

#### Example: Setting a Tone squelch frequency and the Tone squelch.

Set the operating frequency.

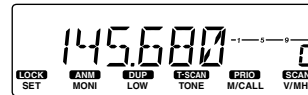

Push [SET LOCK] to enter the Set mode.

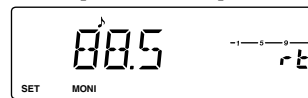

Repeatedly push [SET LOCK] or [MONI ANM PA] to select “**▷**” and “**Ⓞ**” (Tone Squelch frequency).

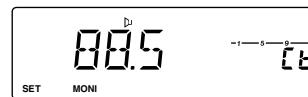

Rotate [DIAL] to select the desired Tone Squelch frequency (Example: 94.8 Hz).

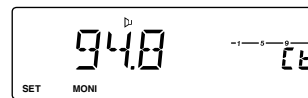

Push any key other than [SET LOCK] or [MONI ANM PA] to save and exit the Set mode.

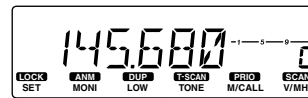

Repeatedly push [TONE T-SCAN] to select “**▷**”.

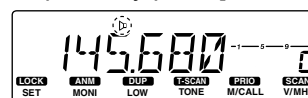

“**▷**” is displayed.

Operate normally.

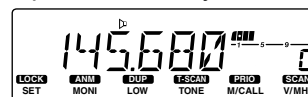

When a signal with a matching tone is received, the squelch opens, and audio is heard.

## 7. TONE SQUELCH AND POCKET BEEP

### Tone/DTCS squelch

#### Using the HM-133V MICROPHONE

1. Set the operating frequency.
2. Push [SET B D-OFF] to enter the Set mode.
3. Set the Tone Squelch frequency, or DTCS code and DTCS polarity.
  - ① See page 7-2 for details.
4. Push [CLR A MW] to save and exit the Set mode.
5. Push [FUNC], and then [SIMP 9 TSQL] or [HIGH 4 DTCS] to select the desired tone or code.
6. Operate normally.
  - ① To manually open the squelch, push [MONI 1 ANM].

**When the Tone or DTCS squelch is selected:**  
When a signal with a matching tone or code is received, the squelch opens, and audio is heard.

  - ① If a signal with an unmatching tone is received, the squelch does not open. However, the S/RF indicator shows the strength of the received signal.

**When the Reverse Tone or DTCS squelch is selected:**  
When a signal with a matching tone or code is received, the squelch remains closed.
7. To cancel the Tone or DTCS squelch, push [FUNC], and then [ENT C T-OFF].
  - ① The tone icon disappears.

#### Example: Setting a Tone squelch frequency and the Tone squelch.

Set the operating frequency.

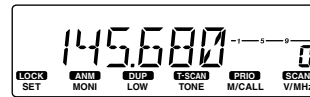

Push [D-OFF SET B] to enter the Set mode.



Repeatedly push [D-OFF SET B] or [T-OFF ENT C] to select “D” and “Ct.”



Push [▲] or [▼] to select the desired Tone Squelch frequency (Example: 94.8 Hz).



Push [MW CLR A] to save and exit the Set mode.

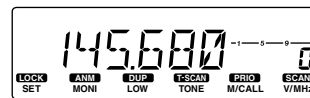

Push [FUNC], and then [TSQL SIMP 9] to turn ON the Tone squelch.

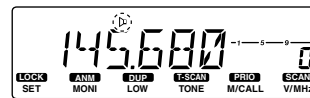

“D” is displayed.

Operate normally.

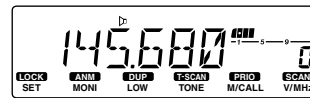











When a signal with a matching tone is received, the squelch opens, and audio is heard.

## Pocket Beep function

This function uses subaudible tones for calling and can be used as a “common pager” to let you know that someone has called when you are away from the transceiver.

### ◆ Waiting for a call from a specific station

1. Set the operating frequency.
2. Push [SET LOCK] to enter the Set mode.
3. Set the Tone Squelch frequency, DTCS code, or DTCS polarity.
  - ① See page 7-2 for details.
4. Push any key other than [SET LOCK] or [MONI ANM PA] to save and exit the Set mode.
5. Repeatedly push [TONE T-SCAN] to until “” and “” or “” and “” are displayed.
  - “” and “” : The CTCSS Pocket Beep function.
  - “” and “” : The DTCS Pocket Beep function.
6. Operate normally.
  - ① To turn OFF the function, repeatedly push [TONE T-SCAN] to until the tone icon disappears.
7. When a signal with a matching tone or code is received, the beep tones sound and “” blinks.
  - ① The beeps sound for 30 seconds.
    - To stop the beeps and the tone icon blinking, push any key.
  - ① When the beep tones are not manually stopped, “” continues blinking until any key is pushed.
  - ① After any key is pushed, “” disappears and the function is turned OFF.
8. Push [PTT] to answer.

### Example: Setting the Tone Squelch frequency and turning ON the CTCSS Pocket Beep function.

Set the operating frequency.

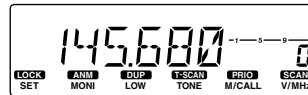

Push [SET LOCK] to enter the Set mode.

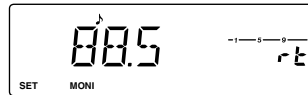

Repeatedly push [SET LOCK] or [MONI ANM PA] to select “” and “Ct.”

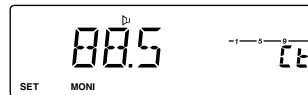



Rotate [DIAL] to select the desired Tone Squelch frequency (Example: 94.8 Hz).



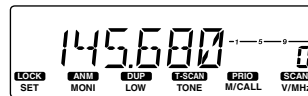

Push any key other than [SET LOCK] or [MONI ANM PA] to save and exit the Set mode.



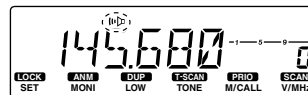

Repeatedly push [TONE T-SCAN] to select “ ” (CTCSS Pocket Beep function).

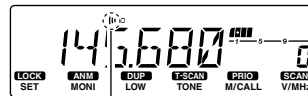

“ ” is displayed.

Operate normally.



When a signal with a matching tone is received, the beep tones sound and “” blinks.

## 7. TONE SQUELCH AND POCKET BEEP

### Pocket Beep function

#### Using the HM-133V MICROPHONE

1. Set the operating frequency.
2. Push [SET B D-OFF] to enter the Set mode.
3. Set the Tone Squelch frequency, or DTCS code and DTCS polarity.
  - ① See page 7-2 for details.
4. Push [CLR A MW] to save and exit the Set mode.
5. Push [FUNC], and then [DUP+ 8 TSQ(L\*)] or [MID 5 DTCS(\*)] to display “(L)” and “(D)” or “(L)” and “(D).”
  - “(L)” and “(D)”: The CTCSS Pocket Beep function.
  - “(L)” and “(D)”: The DTCS Pocket Beep function.
6. Operate normally.
  - ① To turn OFF the function, push [FUNC], and then [ENT C T-OFF].
7. When a signal with matching tones or codes is received, the beep tones sound and “(L)” blinks.
  - ① The beeps sound for 30 seconds.  
To stop the beeps and the tone icon blinking, push any key.
  - ① When the beep tones are not manually stopped, “(L)” continues blinking until [PTT] is pushed.
  - ① After any key is pushed, “(L)” disappears and the function is turned OFF.
8. Push [PTT] to answer.

#### Example: Setting the Tone squelch frequency and turning ON the CTCSS Pocket Beep function.

Set the operating frequency.

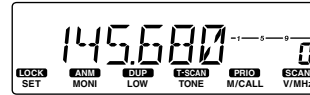

Push [D-OFF SET B] to enter the Set mode.

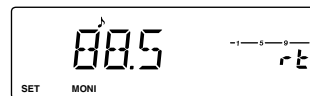

Repeatedly push [D-OFF SET B] or [T-OFF ENT C] to select “(D)” and “Ct.”



Push [▲] or [▼] to select the desired Tone Squelch frequency (Example: 94.8 Hz).



Push [MW CLR A] to save and exit the Set mode.

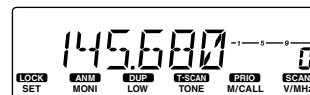

Push [FUNC], and then [TSQ(L\*) DUP+8] to select “(L)” (CTCSS Pocket Beep function).

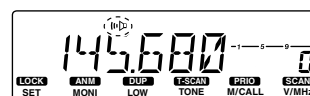

“(L)” is displayed.

Operate normally.

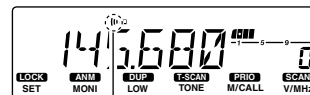

When a signal with a matching tone is received, the beep tones sound and “(L)” blinks.

#### ◇ Calling a waiting station using the Pocket Beep function

A subaudible tone matched with the waiting station's tone or code with correct polarity is needed. Use the Tone or DTCS squelch, or a subaudible tone encoder. (pp. 2-6, 7-2)

## 7. TONE SQUELCH AND POCKET BEEP

### Tone scan

By scanning a signal from a transceiver that has the Tone or DTCS Squelch function or the CTCSS/DTCS Pocket Beep function turned ON, you can determine the Tone frequency or DTCS code needed to open the squelch.

- Set the operating frequency.
- Repeatedly push [TONE T-SCAN] to select the tone type to be checked.
  - “”, “” and “”, “”, or “” can be selected as the target of the Tone scan.
- Hold down [TONE T-SCAN] for 1 second to start the Tone scan.
  - The frequency decimal point blinks.
  - ① Rotate [DIAL] to change the scanning direction.
  - ① Push [MONI ANM PA] to stop or resume the scan.
- When the Tone frequency or DTCS code is detected, the squelch opens, and the detected tone or code is temporarily set in the Memory or Call channel.
  - The detected tone or code is used for the tone encoder or decoder, according to the tone type selected in step 2.
    - “”: Subaudible Tone encoder (Transmit only)
    - “” and “”: DTCS encoder (Transmit only)
    - “”: CTCSS Tone encoder or decoder
    - “”: DTCS code encoder or decoder
- Push any key to cancel the scan.

#### Example: Scanning the Tone frequency on 145.680 MHz.

Set the operating frequency.

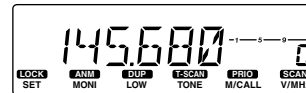

Repeatedly push [TONE T-SCAN] to select “” (CTCSS Squelch function).

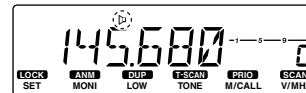

“” is displayed.

Hold down [TONE T-SCAN] for 1 second.

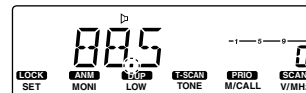

“.” blinks during scanning.

### Using the HM-133V MICROPHONE

- Set the operating frequency.
- Select the tone type to be checked.
  - “”: Push [FUNC], and then [DUP- 7 TONE].
  - “”: Push [FUNC], and then [SIMP 9 TSQ].
  - “”: Push [FUNC], and then [HIGH 4 DTCS].
  - ① To activate “” and “” (DTCS encoder), repeatedly push [TONE T-SCAN] on the transceiver.
- Push [FUNC], and then [SCAN 2 T-SCAN] to start the Tone scan.
  - The frequency decimal point blinks.
  - ① Rotate [DIAL] to changes the scanning direction.
  - ① Push [MONI 1 ANM] to stop or resume the scan.
- When the Tone frequency or DTCS code is detected, the squelch opens, and the detected tone or code is temporarily set into the Memory or Call channel.
  - The detected tone or code is used for the tone encoder or decoder, according to the tone type selected in step 2.
- Push [CLR A MW] to cancel the scan.

#### Example: Scanning the Tone frequency on the 145.680 MHz.

Set the operating frequency.

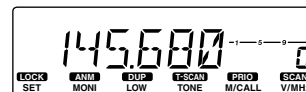

Push [FUNC], and then [TSQ SIMP 9] to select “” (CTCSS Squelch function).

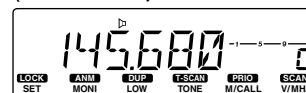

Hold down [T-SCAN SCAN2] for 1 second.

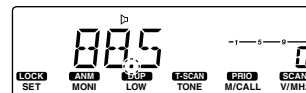

“.” blinks during scanning.

## 7. TONE SQUELCH AND POCKET BEEP

### DTCS encoder (Transmit only)

The DTCS encoder superimposes the selected DTCS code over your transmitted signal.

1. Repeatedly push [TONE T-SCAN] until both “♪” and “D” are displayed.
  - The DTCS encoder is activated.
2. Push [SET LOCK] to enter the Set mode.
3. Set the DTCS code and polarity.
  - ① See page 7-2 for details.
  - ① You can set the DTCS transmit and receive polarity, but the DTCS encoder affects only transmit.
4. Push any key other than [SET LOCK] or [MONI ANM PA] to save and exit the Set mode.

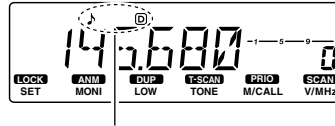

“♪” and “D” is displayed when the DTCS encoder is activated.

## Section 8 SET MODES

---

Using the Set mode .....	8-2
Set mode items.....	8-2
Using the Initial Set mode.....	8-5
Initial Set mode items .....	8-5
Using the Option Set mode .....	8-8
Option Set mode items .....	8-8

## 8. SET MODES

### Using the Set mode

The Set mode is used to change the settings of the transceiver's functions.

1. Push [SET LOCK] to enter the Set mode.
2. Repeatedly push [SET LOCK] or [MONI ANM PA] to select the desired item.
3. Rotate [DIAL] to set an option or value.
4. Push any key other than [SET LOCK] or [MONI ANM PA] to save and exit the Set mode.

### Set mode items

**NOTE:** The default settings may differ, depending on the transceiver version.

#### Repeater Tone frequency (Default: 88.5 Hz)

Selects the Repeater Tone frequency for repeater access.

You can select one of 50 Tone frequencies.

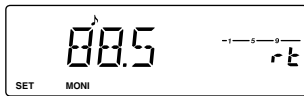

#### Tone Squelch frequency (Default: 88.5 Hz)

Selects the CTCSS Tone frequency for the Tone Squelch function.

You can select one of 50 Tone frequencies.

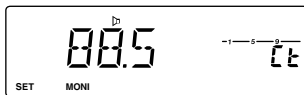

#### Selectable Repeater Tone/Tone Squelch frequencies (unit: Hz)

67.0	79.7	94.8	110.9	131.8	156.7	171.3	186.2	203.5	229.1
69.3	82.5	97.4	114.8	136.5	159.8	173.8	189.9	206.5	233.6
71.9	85.4	100.0	118.8	141.3	162.2	177.3	192.8	210.7	241.8
74.4	88.5	103.5	123.0	146.2	165.5	179.9	196.6	218.1	250.3
77.0	91.5	107.2	127.3	151.4	167.9	183.5	199.5	225.7	254.1

#### DTCS code (Default: 023)

Sets the DTCS code (both encoder and decoder) for the DTCS squelch operation. A total of 104 codes are selectable.

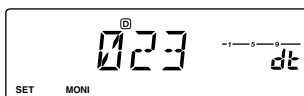

#### Selectable DTCS codes:

023	065	132	205	255	331	413	465	612	731
025	071	134	212	261	332	423	466	624	732
026	072	143	223	263	343	431	503	627	734
031	073	145	225	265	346	432	506	631	743
032	074	152	226	266	351	445	516	632	754
036	114	155	243	271	356	446	523	654	
043	115	156	244	274	364	452	526	662	
047	116	162	245	306	365	454	532	664	
051	122	165	246	311	371	455	546	703	
053	125	172	251	315	411	462	565	712	
054	131	174	252	325	412	464	606	723	

#### DTCS polarity (Default: NN)

Selects the DTCS polarity for transmitting (TX) and receiving (RX).

- NN: Normal polarity is used for both TX and RX.
- NR: Normal polarity is used for TX, Reverse polarity for RX.
- RN: Reverse polarity is used for TX, Normal polarity for RX.
- RR: Reverse polarity is used for both TX and RX.

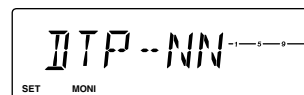

#### Frequency offset (Default: 0.600)

Sets the frequency offset for Duplex (repeater) operation to between 0.000 and 20.000 MHz.

① Push [SCAN V/MHz] to select the 1 MHz tuning step.

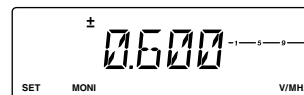

#### Reverse mode (Default: OF)

Turns the Reversed Duplex function ON or OFF.

① See page 2-5 for details.

- OF: Turns OFF the function.
- ON: The receive and transmit frequencies are reversed.

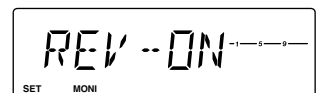
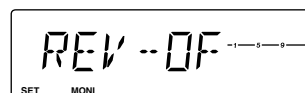

## 8. SET MODES

### Set mode items

#### Tuning step (Default: Depending on the version)

Sets the VFO tuning step to 5, 6.25, 10, 12.5, 15, 20, 25, 30, or 50 kHz.

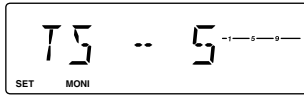

#### Scan Stop timer (Default: 10)

Selects the Scan Stop timer. When receiving a signal, the scan pauses for this set period of time.

- 2 ~ 20: When a signal is received, the scan pauses for 2 ~ 20 seconds (in 2 second steps).
- HO: The scan pauses on a received signal until the signal disappears.

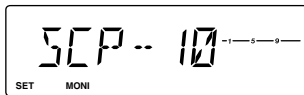

#### Scan Resume timer (Default: 2)

Selects the Scan Resume Timer. When a received signal disappears, the scan resumes for this set period of time.

- 0: The scan resumes immediately after the signal disappears.
- 1 ~ 5: The scan resumes 1 ~ 5 seconds after the signal disappears.
- HO: The scan remains paused for the "SCP" (Scan Stop timer) setting, even if the signal disappears.

**NOTE:** Rotate [DIAL] to resume the scan.

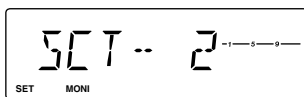

#### Display dimmer (Default: 4)

Sets the backlight brightness level to between 1 (Dark) and 4 (Bright).

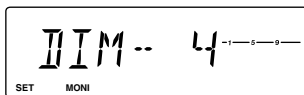

#### Auto dimmer (Default: ATD OF)

Sets the Auto Dimmer brightness.

The Auto Dimmer function automatically reduces the backlight brightness.

- ATD OF: Turns OFF the function. The display backlight is continuously turned ON while the transceiver is turned ON.
- AT OF: The display backlight is automatically turned ON when operating the transceiver. The backlight is automatically turned OFF when no operation has been performed for 5 seconds.
- AT D1 to D3: The display backlight is automatically turned ON when operating the transceiver. The backlight automatically returns to the D1 ~ D3 set level when no operation has been performed for 5 seconds.

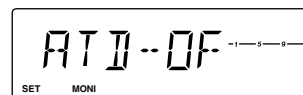

#### Display contrast (Default: 2)

Sets the LCD contrast to between 1 (lowest contrast) and 4 (highest contrast).

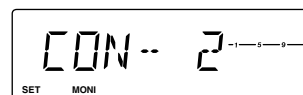

#### Transmit permission (Default: ON)

Turns the TX Inhibit function ON or OFF.

- OF: Turns OFF the function.
  - ON: Transmit is inhibited.
- ① This function can be independently set for each Memory channel, Call channel, and the VFO mode.

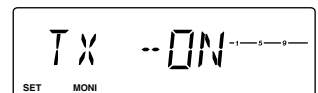
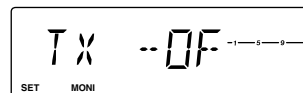

## 8. SET MODES

### Set mode items

#### Channel Skip setting (Default: OF)

Turns the Skip function ON or OFF.

- OF: Turns OFF the function.
- ON: The selected Memory channel will be a Skip channel and skipped during a scan.

- ① This item is displayed only when the Set mode is accessed in the Memory mode.
- ① This function can be independently set for each Memory channel.

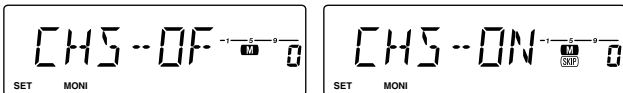

#### Bank setting

(Default: --- (No Memory Bank is selected))

Assigns the desired Memory channels and Scan Edge channels to the Memory Bank for easy Memory management.

A total of 10 Memory Banks (A to J) are selectable.

- ① This item is displayed only when the Set mode is accessed in the Memory mode.
- ① See page 3-11 for details.

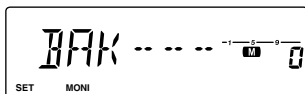

#### Bank Link function (Default: OF)

Turns the Bank Link function ON or OFF.

- OF: The selected Memory Bank is not linked.
- ON: The selected Memory Bank is linked and becomes the target of the Bank Link scan.

- ① This item is displayed only when the Set mode is accessed in the Memory mode.

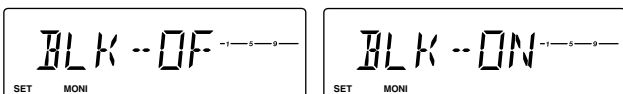

##### • Setting the bank link

1. Rotate [DIAL] to select "ON."

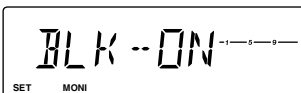

2. Push [SET LOCK] to select the desired bank.

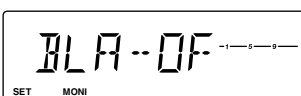

- ① Push [MONI ANM PA] to select the previous bank.
- ① When Bank A is displayed, push [MONI ANM PA] to select the item of step 1.  
When Bank J is displayed, push [SET LOCK] to select the next Initial Set mode item.

3. Rotate [DIAL] to select "ON."

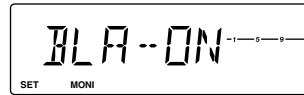

- The selected Bank is linked.
4. Repeat steps 2 and 3 until all desired banks are linked.

#### Wide/Narrow (Default: W (Wide))

Sets both the transmit and receive passband width to wide or narrow.

- ① This function can be independently set for each Memory channel, Call channel, and VFO.

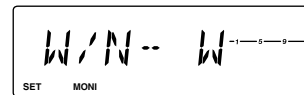

#### Weather alert (Default: OF)

For the USA version, an NOAA broadcast station transmits a Weather Alert tone before any important weather information.

- OF: The Weather Alert tone is not detected.
- ON: The previously selected Weather channel is checked every 5 seconds while operating. When the alert is detected, a beep sounds, and "AL.T" and the Weather channel are alternately displayed.

- ① This item is displayed in only the USA version.
- ① See page 9-2 for details.

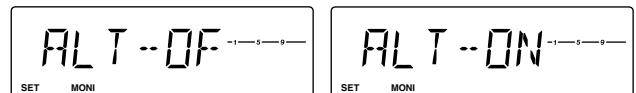

#### MIC gain (Default: Depending on the version)

Sets the microphone sensitivity to HI (High) or LO (Low) to suit your preference.

When "HI" is selected, the microphone will be more sensitive to your voice.

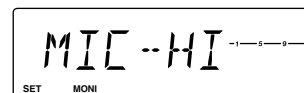

## 8. SET MODES

### Using the Initial Set mode

The initial Set mode can be accessed when the transceiver is turned ON, and allows you to set seldom-changed settings. In this way, you can “customize” the transceiver to suit your preference and operating style.

1. While holding down [SET LOCK], hold down [⓪] for 1 second to enter the Initial Set mode.
2. Repeatedly push [SET LOCK] or [MONI ANM PA] to select the desired item.
3. Rotate [DIAL] to select an option or value.
4. Push [⓪] to save and exit the Initial Set mode.

### Initial Set mode items

**NOTE:** The default settings may differ, depending on the transceiver version.

#### Key-touch beep (Default: ON)

Turns the confirmation beeps ON or OFF.

- OF: No beep sounds.
- ON: A beep sounds when a key is pushed.

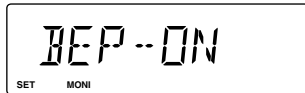
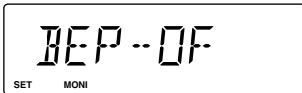

#### Time-out timer (Default: OF)

To prevent an accidental prolonged transmission, the transceiver has a Time-out Timer function. The function inhibits continuous transmissions longer than this set period of time.

- OF: Turns OFF the function.
- 1 ~ 30: Transmission is cut OFF after the set period of time ends (1 to 30 minutes).

Approximately 10 seconds before the Time-out timer is activated, the transceiver sounds a beep tone as a warning.

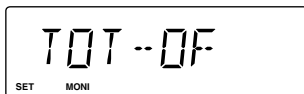

#### Auto Repeater (Default: R1)

The Auto Repeater function automatically turns the duplex settings and the tone encoder ON or OFF.

- ① This item is displayed in only the USA version.
- ② The frequency offset and the Repeater Tone frequency are not changed by this function. Reset these frequencies, if necessary.
- OF: Turns OFF the function.
- R1: Turns ON the duplex settings only.
- R2: Turns ON the duplex settings and the tone encoder.

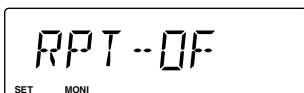

#### Auto Power OFF (Default: OF)

Selects whether or not to automatically turn OFF the transceiver after inactivity for this set period of time.

- ① When the function is ON, “AO” is displayed in the function display.
- ② Beeps sound when turning OFF the transceiver. If you operate the transceiver during this period of time, the Auto Power OFF timer is reset.
- OF: Does not turn OFF the transceiver.
- 30/1H/2H: Turns OFF the transceiver after inactivity for this set period of time (30 minutes, 1 hour, or 2 hours).

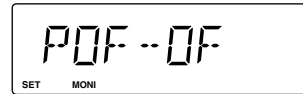

#### Repeater Lockout (Default: OF)

Sets the transmit lockout (temporary transmission inhibit) capability.

- OF: Turns OFF the function.
- RP: Transmit capability is inhibited when a signal with an unmatched subaudible tone is received.
- BU: Transmit capability is inhibited when a signal is received.

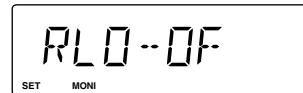

#### Squelch delay (Default: S)

Sets the squelch delay to short or long. The delay prevents the squelch from repeatedly opening and closing when receiving the same signal.

- S: Short squelch delay.
- L: Long squelch delay.

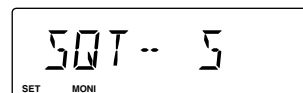

## 8. SET MODES

### Initial Set mode items

#### Squelch type (Default: OF)

Selects the squelch type.

- OF: Noise squelch.
- SS: S-meter squelch.  
The S-meter Squelch function disables the audio output from the speaker when the received signal is weaker than the specified S-meter squelch level.  
To turn ON the function, rotate [SQL] clockwise to a point past the 12 o'clock position.
- AT: Squelch attenuator.  
Approximately 20 dB of attenuation is obtained at the maximum setting.  
To turn ON the function, rotate [SQL] clockwise to a point past the 12 o'clock position.

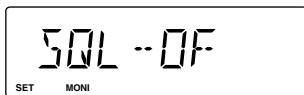

#### Tone burst (Default: OF)

Turns the Tone Burst function ON or OFF.

- OF: When you transmit a signal that superimposes a CTCSS tone, the other station may hear a short burst of noise from their receiver just after you stop transmitting.
- ON: When you transmit a signal that superimposes a CTCSS tone, the function mutes the noise from being heard in the other station's receiver.

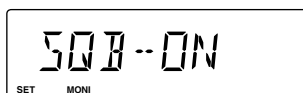
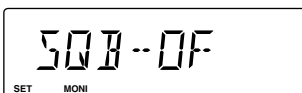

#### DTMF speed (Default: 1)

Selects the DTMF transmit speed.

- 1: Transmits the DTMF codes at about 100 milliseconds per code (5 characters per second).
- 2: Transmits the DTMF codes at about 200 milliseconds per code (2.5 characters per second).
- 3: Transmits the DTMF codes at about 300 milliseconds per code (1.6 characters per second).
- 5: Transmits the DTMF codes at about 500 milliseconds per code (1 character per second).



#### Display type (Default: FR)

Selects the display type of the Memory mode.

- FR: The entered frequency is displayed.
- CH: The Memory Channel number is displayed.
- NM: The channel name is displayed.

① When "CH" is selected, the usable functions and Set mode items will be restricted as shown below.

##### Usable functions when "CH" is selected:

- Memory scan
- Selecting an output power
- Adjusting the volume or squelch level
- Monitor function
- Lock function
- Set mode  
(Settable items are "SCP" (Scan Stop timer), "SCT" (Scan Resume timer), "DIM" (Display dimmer), "ATD" (Auto dimmer), "CON" (Display contrast), "BLK" (Bank Link function), and "MIC" (MIC gain).)

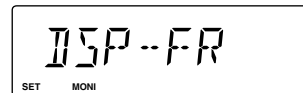

#### Voltage display (Default: ON)

Selects whether or not to display the power source voltage.

- OF: The supplied voltage is not displayed.
- ON: When the transceiver is turned ON, the supplied voltage is displayed.

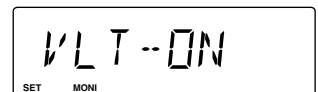
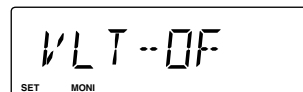

#### [BANK/OPT] key (Default: BAK)

Assigns the function to [BANK/OPT].

- BAK: The Memory Bank mode and the Option Set mode are assigned.  
When the Memory mode is selected, push [BANK/OPT] to enter the Memory Bank mode. Hold down [BANK/OPT] for 1 second to enter the Option Set mode.
- EMR: The Emergency Call function is assigned.  
Hold down [BANK/OPT] for 3 second to turn ON the function.
- TVo: The Temporary Volume function and the Option Set mode are assigned.  
Push [BANK/OPT] to change the volume level to the value set in the Temporary volume setting.  
Hold down [BANK/OPT] for 1 second to enter the Option Set mode.

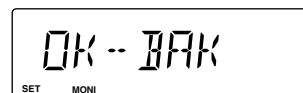

## 8. SET MODES

### Initial Set mode items

#### **Emergency channel** (Default: VFO)

Selects a channel used for an emergency purpose.

- VFO: The frequency set in the VFO mode is set as an Emergency frequency.
- MR 0 ~ 199: The selected Memory channel is set as an Emergency frequency.
- MR 1A ~ 3B: The selected Scan Edge channel is set as an Emergency frequency.
- CAL: The Call channel is set as an Emergency frequency.

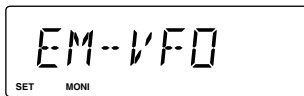

#### **Emergency Alert volume** (Default: MAX)

Selects whether or not to sound the beeps, the alert, and the received signal when using the Emergency Call function.

- MAX: The countdown beeps and the long beep will sound when the Emergency Call function is turned ON.  
An Emergency alert will sound at maximum volume when the Emergency signal is transmitted.  
The Emergency signal will sound at maximum volume when it is received.
- MIN: The countdown beeps and the long beep will not sound, even if the Emergency Call function is turned ON.  
No Emergency alert will sound, even if the Emergency signal is transmitted.  
No Emergency signal will sound, even if it is received.

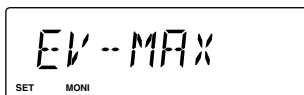

#### **Temporary volume** (Default: 0)

Sets the volume level when the Temporary Volume function is turned ON to between 0 (OFF), 1 (minimum) and 32 (maximum).

- ① You can use the function as "One-Touch Mute" by setting this item to "0."

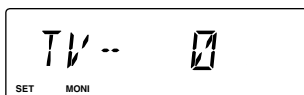

## 8. SET MODES

### Using the Option Set mode

The Option Set mode can be accessed when “BAK” or “TVo” is set to “OK” ([BANK/OPT] key) setting in the Initial Set mode (p. 8-6).

1. Hold down [BANK OPT] for 1 second to enter the Option Set mode.
2. Push [SET LOCK] or [MONI ANM PA] to select the desired item.
3. Rotate [DIAL] to set an option or value.
4. Push any key other than [SET LOCK] or [MONI ANM PA] to save and exit the Option Set mode.

### Option Set mode items

**NOTE:** The default settings may differ, depending on the transceiver version.

#### **DTMF Memory encoder** (Default: OF)

Turns the DTMF Memory encoder ON or OFF.

① When the function is turned ON, the 100 MHz digit on the function display is changed to “d.”

① See page 6-2 for details.

- OF: Turns OFF the function.
- ON: You can enter and transmit a DTMF code.

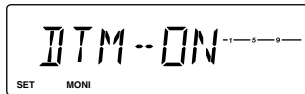
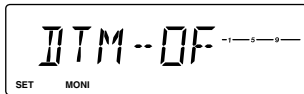

#### **AF output selection** (Default: OF)

The IC-V3500 has 3 AF output selections. Select the audio output that suits you.

① This item may not be displayed, depending on the transceiver version.

① When the setting of this item is changed, the “RSP” (AF output selection) setting in the Marine Set mode will be set as follows.

- OF: The received audio is output from only the speaker jack.  
(When no external speaker is connected, audio is output from the internal speaker.)
- AL: The received audio is output from both the internal speaker and the speaker jack.
- IN: The received audio is output from only the internal speaker.

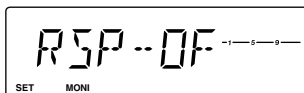

## Section 9

## OTHER FUNCTIONS

---

Weather channel operation (For only the USA version) .....	9-2
◇ Selecting a Weather channel .....	9-2
◇ Using the Weather Alert function.....	9-2
Microphone keys .....	9-3
◇ [F-1] and [F-2] on the HM-133V MICROPHONE .....	9-3
◇ The [UP] and [DN] keys on a microphone other than the HM-133V .....	9-3
One-touch PTT function .....	9-4
About the volume level and the squelch level .....	9-4
Resetting .....	9-5
◇ Partial Reset.....	9-5
◇ All Reset.....	9-5

## 9. OTHER FUNCTIONS

### Weather channel operation (For only the USA version)

The USA version transceiver has 10 preset Weather channels.

#### ◇ Selecting a Weather channel

- Repeatedly push [M/CALL PRIO] to select the Weather Channel mode.
  - The Weather Channel number is displayed.
- Rotate [DIAL] to select the desired Weather channel.
- Push [V/MHz SCAN] to return to the VFO mode.

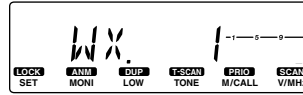

When Weather channel 1 is selected.

#### The Weather channel list

Weather channel	Frequency (MHz)	Weather channel	Frequency (MHz)
1	162.550	6	162.500
2	162.400	7	162.525
3	162.475	8	161.650
4	162.425	9	161.775
5	162.450	10	163.275

#### ◇ Using the Weather Alert function

The National Oceanographic and Atmospheric Administration (NOAA) broadcast stations transmit Weather Alert tones before important weather announcements. When the Weather Alert function is turned ON, the transceiver checks the selected Weather channel every 5 seconds for an announcement.

When the alert signal is detected, "AL.T" and the Weather channel are alternately displayed, and a beep sounds until any operation is performed. The transceiver automatically detects a Weather Alert tone on the selected Weather channel or while scanning.

- Select the desired Weather channel, and then push [V/MHz SCAN].
- Repeatedly push [SET LOCK] or [MONI ANM PA] to select "ALT" (Weather Alert function).
- Rotate [DIAL] to select "ON."
- Push any key other than [SET LOCK] or [MONI ANM PA] to save and exit the Set mode.
- Operate normally.
- When an alert is detected, a beep sounds, and "AL.T" and the Weather channel are alternately displayed.
  - Push any key to stop the beep.

**NOTE:** When the Weather Alert function is turned ON, the received audio will be momentarily interrupted approximately every 5 seconds while receiving a signal on a frequency other than the Weather channel. To cancel these interruptions, turn OFF the function in the Set mode. (p. 8-4)

#### Example: Selecting Weather channel 1 and turning ON the Weather Alert function.

Select the desired Weather channel, and then push [V/MHz SCAN].

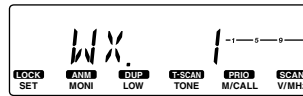

Push [SET LOCK] to enter the Set mode.

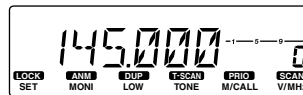

Repeatedly push [SET LOCK] or [MONI ANM PA] to select "ALT," and then rotate [DIAL] to select "ON."

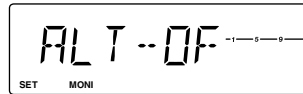

Push any key other than [SET LOCK] or [MONI ANM PA].

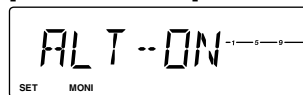

Operate normally.

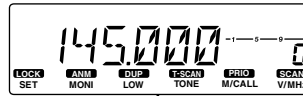

When an Weather alert is detected, a beep sounds, "AL.T" and the selected Weather channel are alternately displayed.

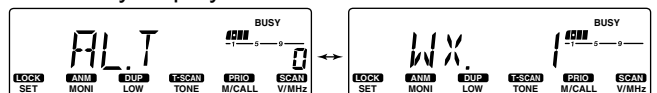

9. OTHER FUNCTIONS

## Microphone keys

### ◇ [F-1] and [F-2] on the HM-133V MICROPHONE

The following settings can be assigned to the [F-1] and [F-2] function keys on the HM-133V.

- Operating frequency
- Repeater settings (Offset direction, Offset frequency, tone ON/OFF, and Repeater Tone frequency)
- Tone/DTCS squelch (ON/OFF, Tone frequency, DTCS code, and its polarity)
- Transmit output power
- The Settings of the Set mode, Initial Set mode, and Option Set mode items



#### Assign the settings:

1. Assign the settings you want to use.
2. Hold down [F-1] or [F-2] for 1 second.
  - Three beeps sound and the settings are assigned.

**TIP:** To assign the settings of the Set mode, Initial Set mode, and Option Set mode items, push [FUNC], and then hold down [F-1] or [F-2] for 1 second.

#### Using the assigned settings:

- Push [F-1] or [F-2].
- “F1” or “F2” is displayed.

**TIP:** To recall the settings of the Set mode, Initial Set mode, and Option Set mode items, push [FUNC], and then [F-1] or [F-2].

- “ALLF-1” or “ALLF-2” is displayed.

“F1” is displayed.

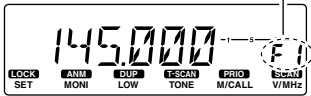

When [F-1] is pushed.

“F2” is displayed.

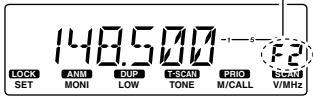

When [F-2] is pushed.

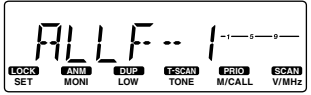

When [FUNC] is pushed, and then [F-1] is pushed.

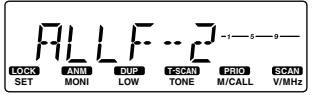

When [FUNC] is pushed, and then [F-1] is pushed.

### ◇ The [UP] and [DN] keys on a microphone other than the HM-133V

The [UP] and [DN] keys on a microphone other than the HM-133V have the following functions.

- Push to change the operating frequency, Memory channel, Set mode setting, and so on.
- Hold down either key for 1 second to start scanning.
  - ① The scanning direction follows the name of the key ([UP]: Channel up, [DN]: Channel down).
  - ① Push [MONI ANM PA] to stop or resume the scan.
  - ① Push either key again to cancel the scan.

#### Example: HM-154

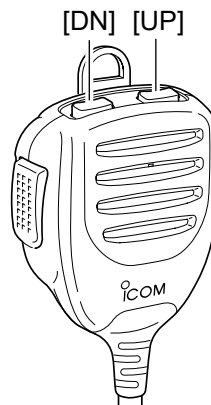

9. OTHER FUNCTIONS

## One-touch PTT function

The PTT switch on the HM-133V can be used as the One-touch PTT function.

This function enables you to transmit without continuously holding down [PTT].

① To prevent accidental continuous transmissions with this function, the transceiver has a time-out timer. See page 8-5 for details.

1. Push [FUNC], and then [PRIO 3 PTT-M] to turn ON the One-touch PTT function.
  - The activity indicator lights green.
2. Push [PTT] to transmit, and push again to receive.
  - ① A beep sound at the start of transmission and when returning to reception.
  - ① The activity indicator lights red and **TX** blinks while transmitting.
3. Push [FUNC], and then [PRIO 3 PTT-M] to turn OFF the function.
  - The activity indicator disappears.

When the function is turned ON, the activity indicator lights as described below, and indicates the following states.

Lights green: While receiving

Lights red: While transmitting

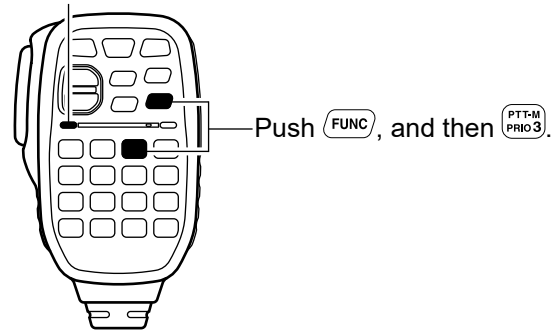

## About the volume level and the squelch level

When the volume level or the squelch level is changed using the HM-133V:

- “VOL” or “SQL” is displayed.
- The level will be displayed in the Memory channel number readout and the S/RF indicator.

The S/RF indicator is displayed as shown below, depending on the level.

The volume level or the squelch level	Indicator
32	
26 ~ 31	
21 ~ 25	
16 ~ 20	
11 ~ 15	
6 ~ 10	
1 ~ 5	

When the volume level is changed using the HM-133V

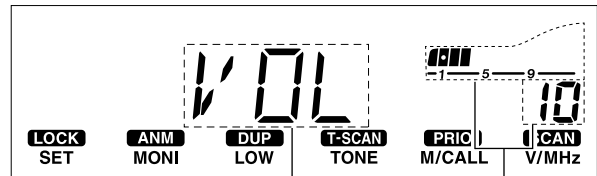

“VOL” is displayed. The volume level is displayed by a number and an indicator.

When the squelch level is changed using the HM-133V

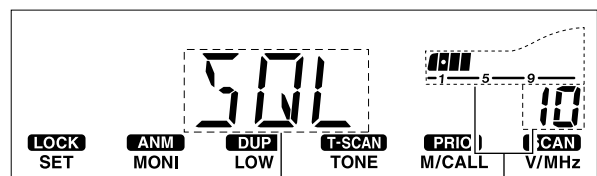

“SQL” is displayed. The squelch level is displayed by a number and an indicator.

## 9. OTHER FUNCTIONS

### Resetting

Occasionally, erroneous information will be displayed when, for example, first applying power. This may be caused externally by static electricity or by other factors. If this problem occurs, turn OFF the transceiver. After waiting a few seconds, turn ON the transceiver again. If the problem is still there, perform a Partial reset or an All reset.

**BE CAREFUL!** An All Reset clears all settings and returns all settings to the factory defaults.

#### ◇ Partial Reset

1. Hold down [⏻] for 1 second to turn OFF the transceiver.
2. While holding down [V/MHz SCAN], hold down [⏻] for 1 second to turn ON the transceiver.

**TIP:** A Partial Reset resets the operating settings to their default values (VFO frequency, VFO settings, the Set mode, the Initial Set mode, and the Option Set mode contents) without clearing the items below:

- Memory channel contents
- Scan Edge channel contents
- Call channel contents
- DTMF Memory contents

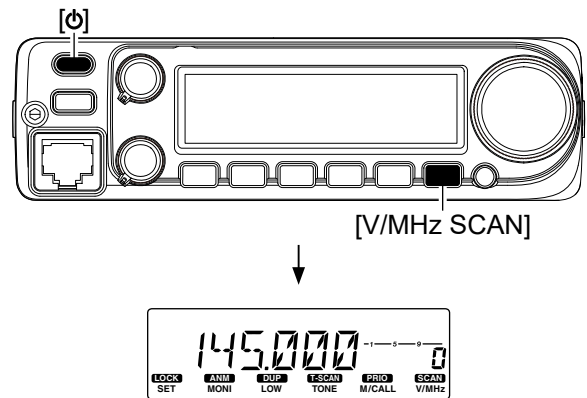

#### ◇ All Reset

1. Hold down [⏻] for 1 second to turn OFF the transceiver.
2. While holding down [SET LOCK] and [S.MW MW], hold down [⏻] for 1 second to turn ON the transceiver.
  - "CLEAR" is displayed.

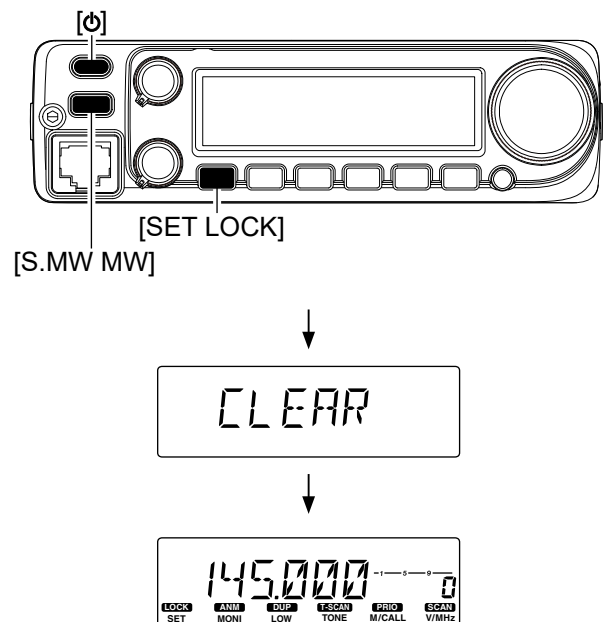

# Section 10 PROGRAMMING

---

Programming operation .....	10-2
◇ Cloning between two transceivers.....	10-2
◇ Programming using a PC .....	10-3

## Programming operation

The transceiver has a data copying capability. This function is useful for copying all of the settings and entered contents from one transceiver to another.

You can also program data from a PC to a transceiver, using the optional CS-V3500 PROGRAMMING SOFTWARE.

### ◇ Cloning between two transceivers

An optional OPC-474 PROGRAMMING CABLE is required.

1. Connect the master and sub-transceivers using the OPC-474 through their [SP] jacks.
  - The master transceiver is used to send data to the sub-transceiver.
2. Turn ON the sub-transceiver.
3. While holding down [M/CALL PRIO], hold down [⓪] for 1 second to turn ON the master transceiver and enter the Cloning mode.
  - “CLONE” is displayed.
4. Push [S.MW MW] on the master transceiver to start cloning.
  - “CL OUT” is displayed on the master transceiver’s display, and the S/RF meter shows that data is being transferred to the sub-transceiver.
  - “CL IN” is displayed on the sub-transceiver’s display, and the S/RF meter shows that data is being received from the master transceiver.
  - When the cloning is finished, the master transceiver returns to the cloning mode screen, and the sub-transceiver displays “CL OK.”
5. Turn OFF both transceivers, and then turn ON the transceivers again to exit the cloning mode.

**NOTE: DO NOT** push any key on the sub-transceiver while cloning. This will cause an error. When “CL NG” is displayed, a cloning error has occurred. In this case, follow the cloning procedures again.

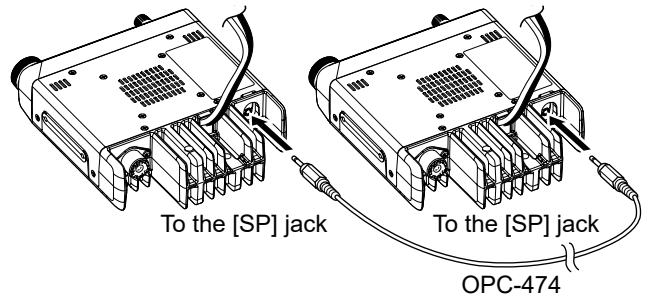
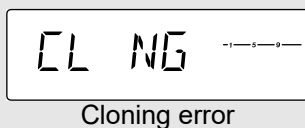

#### The master transceiver

While holding down [M/CALL PRIO], turn ON the transceiver.

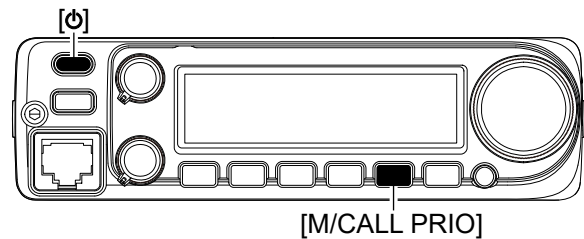

During cloning mode

Push [S.MW MW] to start cloning.

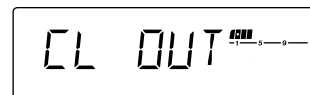
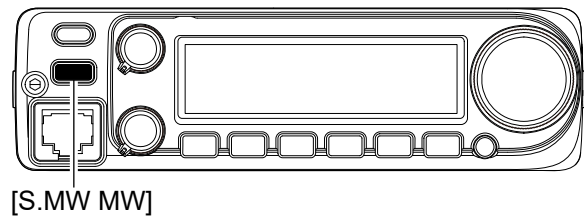

While cloning

#### The sub-transceiver

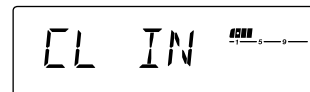

While cloning

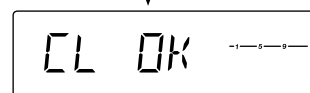

The cloning is completed.

## 10. PROGRAMMING

### Programming operation

#### ◇ Programming using a PC

Copy the data from a PC using the optional CS-V3500 PROGRAMMING SOFTWARE and OPC-478UC or OPC-478UC-1 PROGRAMMING CABLE.

Refer to the INSTRUCTIONS and the Help file that come with the programming software for details.

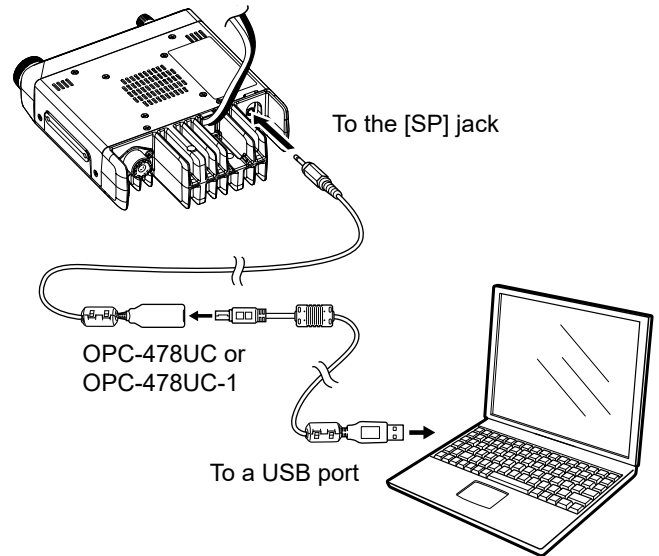

# Section 11    **INSTALL AND CONNECTIONS**

---

Connecting a microphone.....	11-2
Connecting a DC power cable.....	11-2
Installing in a vehicle .....	11-3
◇ Mounting the transceiver .....	11-3
Installing an antenna .....	11-4
◇ Antenna location.....	11-4
Connecting to a battery .....	11-4
Fuse replacement.....	11-5

## 11. INSTALL AND CONNECTIONS

### Connecting a microphone

Connect the supplied microphone to the 8-pin modular socket on the front panel of the transceiver.

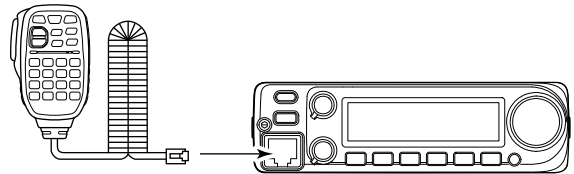

### Connecting a DC power cable

Confirm that the transceiver is OFF, and then connect a 13.8 V DC power source with at least 15 A capacity.

**⚠ WARNING! NEVER** remove the fuse holders from the DC power cable.

**CAUTION: DO NOT** reverse the polarity when connecting to the DC power cable.

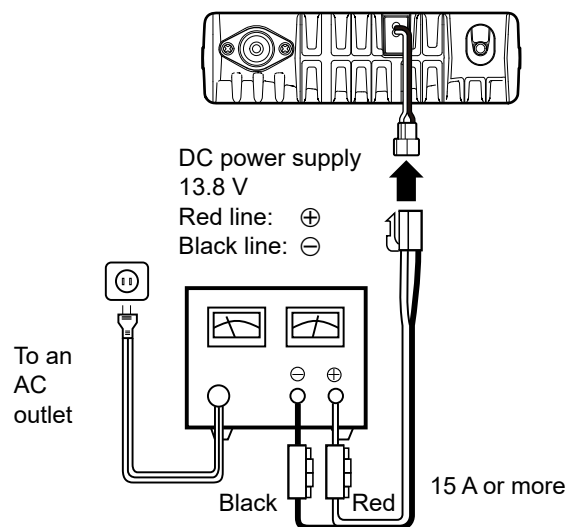

## Installing in a vehicle

⚠ **DANGER!** NEVER place the transceiver where airbag deployment may be obstructed.  
 ⚠ **WARNING!** NEVER place the transceiver where normal operation of the vehicle may be hindered or where it could cause bodily injury.  
**DO NOT** place the transceiver where hot or cold air blows directly onto it.

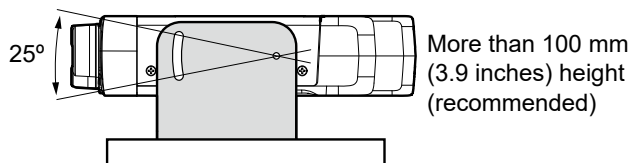

**NOTE:** Contact your Icom dealer or car dealer for advice on installing in a vehicle.

### ◇ Mounting the transceiver

You can install the transceiver on the dashboard or the console of your vehicle with the supplied mounting bracket.

1. Drill 4 holes where the supplied mounting bracket is to be installed.  
 ① Approximately 5.5 ~ 5.6 mm (0.21 ~ 0.22 inch)(d) when using nuts, approximately 2 ~ 3 mm (0.08 ~ 0.12 inch)(d) when using self-tapping screws.
2. Insert the supplied screws, nuts, and washers through the mounting bracket and tighten.
3. Adjust the angle to suit your needs.

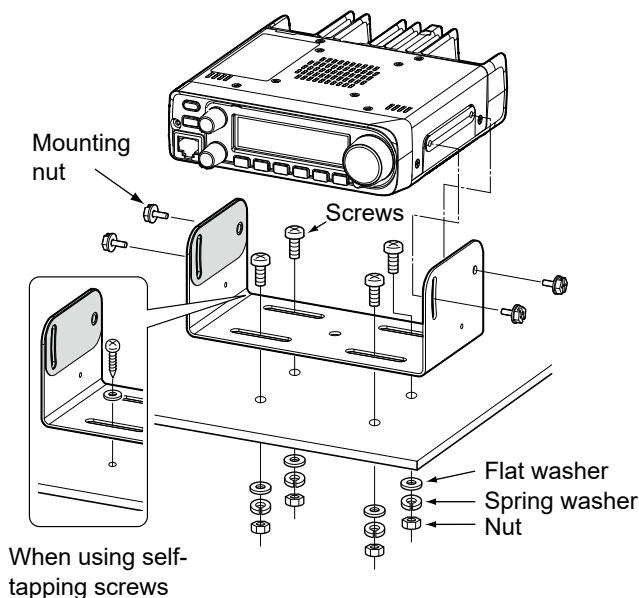

## 11. INSTALL AND CONNECTIONS

### Installing an antenna

To obtain maximum performance from the transceiver, select a high-quality antenna and mount it in a good location.

#### ◇ Antenna location

Roof-mount antenna

(Drill a hole or use a magnetic mount.)

Trunk-mount antenna

Gutter-mount antenna

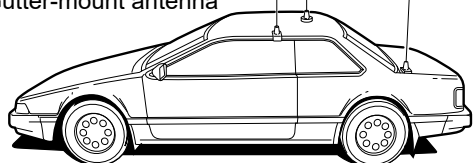

Connect the antenna coaxial cable to the antenna connector on the rear panel of the transceiver.

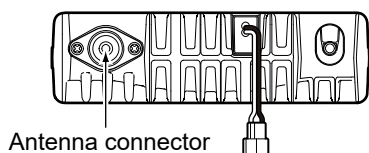

**NOTE:** Make the coaxial cable as short as possible.

### Connecting to a battery

#### ⚠ WARNING!

- **NEVER** remove the fuses from the cable connecting the transceiver to a power source, especially a car battery.
- **NEVER** connect the transceiver directly to a 24 V battery. The transceiver must be connected to a 24 V battery through the DC-DC converter.

#### CAUTION:

- **DO NOT** use a cigarette lighter socket as a power source when operating in a vehicle. The plug may cause voltage drops, and ignition noise may be superimposed onto transmit or receive audio.
- **DO NOT** pull or tightly bend the DC power cable.
- **DO NOT** reverse the polarity when connecting the DC power cable.
- Use a rubber grommet when passing the DC power cable through a metal plate to prevent a short circuit.
- The transceiver may not receive well on some frequencies when installed in a hybrid or electric vehicle (fuel cell vehicle). This is because the vehicle's electric components, such as the inverter system, generate a lot of electrical noise.

#### CONNECTING TO A VEHICLE BATTERY

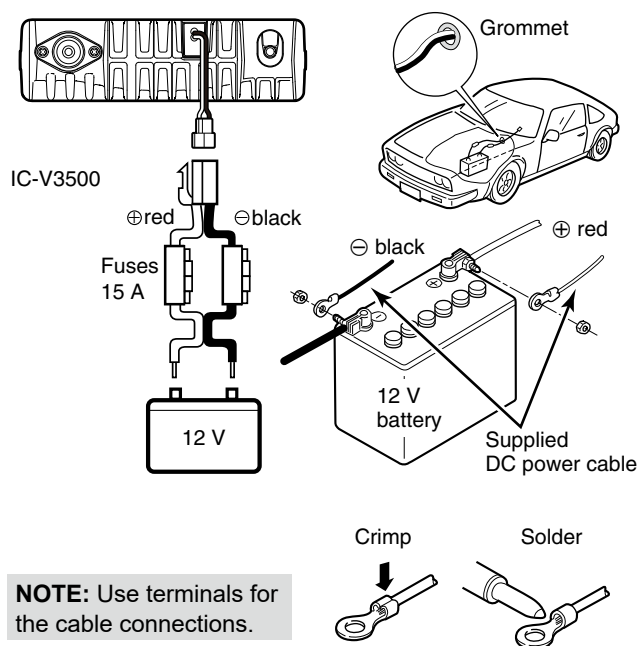

**NOTE:** Use terminals for the cable connections.

## Fuse replacement

A fuse is installed in each fuse holder of the supplied DC power cable. If a fuse blows or the transceiver stops functioning, find and repair the cause of the problem. Then replace the damaged fuse with a new, adequately rated fuse (FGB 15 A).

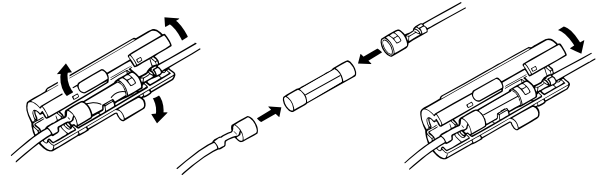

**⚠ WARNING!**

- **NEVER** remove the fuse holders from the DC power cable. **USE** only the applicable fuses.
- **NEVER** replace the fuse when the DC cable is connected to the power source.

**Fuse Coding explanation**

Fuse Coding: FUSE 125 V 15 A

Fuse Voltage Rating: 125 Volts

Fuse Current Rating: 15 Amperes

# Section 12 TROUBLESHOOTING

---

Troubleshooting..... 12-2

### Troubleshooting

The following sentences are designed to help you correct problems that are not equipment malfunctions. If you are unable to locate the cause of a problem or solve it through the use of this troubleshooting, contact your nearest Icom Dealer or Service Center.

#### **The transceiver does not turn ON.**

- The DC power cable is not properly connected.  
→ Properly reconnect the DC power cable. (p. 11-2)
- The polarity of the power connection is reversed.  
→ Reconnect the DC power cable observing the proper polarity. Replace the fuse, if blown. (pp. 11-2, 11-5)
- A DC power cable fuse is blown.  
→ Find and repair the cause of the problem, and then replace the damaged fuse with a new one. (p. 11-5)
- The power source voltage is not correct.  
→ Apply the correct 13.8 V DC. (p. 11-2)

#### **No sound comes from the speaker.**

- The volume level is too low.  
→ Rotate [VOL] clockwise to obtain a suitable listening level. See the Basic manual for details.
- The Audio Mute function is activated.  
→ Push any switch or key to deactivate it. See the Basic manual for details.
- The squelch is tightly closed.  
→ Rotate [SQL] to adjust the squelch level to the threshold point. See the Basic manual for details.
- A selective call or the Squelch function is activated, such as the Pocket Beep function or the Tone/DTCS squelch.  
→ Turn OFF those functions. (pp. 7-3, 7-5)

#### **Sensitivity is low, and only strong signals are audible.**

- The antenna feedline or the antenna connector solder has poor contact or is shorted.  
→ Check, and if necessary, replace the feedline or resolder the antenna connector. (p. 11-4)
- The S-meter Squelch or Squelch Attenuator function is activated.  
→ Set [SQL] to between the 10 and 12 o'clock position. See the Basic manual for details.  
→ Turn OFF the S-meter squelch or Squelch Attenuator function. (p. 8-6)

#### **No direct contact is possible with other stations.**

- The other station is using the tone/DTCS squelch.  
→ Set the appropriate Tone frequency or DTCS code, and then turn ON the Tone or DTCS squelch. (pp. 7-2, 7-3)
- The transceiver is set to the plus or minus Duplex mode.  
→ Repeatedly hold down [LOW DUP] for 1 second to select the Simplex mode. See the Basic manual for details.

#### **A repeater cannot be accessed.**

- The wrong frequency offset is set.  
→ Correct the frequency offset. (p. 8-2)
- The wrong Repeater Tone frequency is set.  
→ Correct the Repeater Tone frequency. (p. 8-2)

#### **Frequency cannot be set.**

- The Lock function is activated.  
→ Turn OFF the function. See the Basic manual for details.
- The Priority watch is paused on the watch frequency.  
→ Cancel the watch. (p. 5-3)

#### **Frequency cannot be set using the microphone.**

- The Microphone Keypad Lock function is activated.  
→ Push [FUNC], and then [SQL ▼ # 16KEY-L] to turn OFF the function. See the Basic manual for details.
- The Priority watch is paused on the watch frequency.  
→ Cancel the watch. (p. 5-4)

---

## 12. TROUBLESHOOTING

### Troubleshooting

#### **Some Memory channels cannot be selected using the microphone keypad.**

- The selected Memory channel is not yet entered.  
→Rotate [DIAL] to check whether or not the channel has been entered.

#### **The scan does not start.**

- The squelch is open.  
→Rotate [SQL] to adjust the squelch level to the threshold point. See the Basic manual for details.
- The same frequencies are entered into the Scan Edge channels.  
→Enter different frequencies into the Scan Edge channels. (p. 4-10)
- Only one Memory channel is entered, or other channels are set as Skip channels.  
→Enter other Memory channels or clear the Channel Skip setting in the desired channels. (p. 4-11)
- The Priority watch function is activated.  
→Cancel the watch. (p. 5-4)

#### **Transmission is automatically cut off.**

- The Time-out timer is activated.  
→Turn OFF the timer. (p. 8-5)

#### **Transmission continues even when [PTT] is released.**

- The One-touch PTT function is activated.  
→Turn OFF the function. (p. 9-4)

#### **The function display shows erroneous information.**

- The CPU is malfunctioning.  
→Reset the CPU. (p. 9-5)

